

2025

Happy
New
Year

To Polat Makina
Social Benefit Award

In PGR
Top Level Appointment

From Polat Makina
Türkiye Record

On November 26th,
World Olive Tree Day

POLAT *life* CONTENTS

03

CORPORATE

25

HIGHLIGHTS

33

**AROUND THE WORLD
THROUGH OUR TRADE
FAIR PARTICIPATION**

37

CITIES WHERE WE LEFT OUR MARK

41

POLART

45

OUR PETS AND US



PUBLISHER

Polat Group Holding Anonim Şirketi

OWNER

Olcay POLAT

Chairman of the Board of
Directors Polat Group Holding

EDITORS

Ceyda GÖNÜL
Corporate Communication Executive
Mehmet KESKİN
Senior Corporate Communications Specialist
Polat Group Holding

MANAGEMENT LOCATION

Ata Osb Mah. Astim 1. Cad.
No: 4 Efeler/AYDIN
T: +90 256 231 04 70 (pbx)
F: +90 256 231 04 71

TYPE OF PRINTING

Local Periodical Free
DESIGN & PRINT PREPARATION
PERON MEDIA
Adnan Menderes Mah. 519. Sk.
No: 4 D:A, 09000 Efeler/AYDIN
T: +90 256 911 00 07



Dear Polat Life Readers,

As Polat Group Holding, we are happy to meet you in the new issue of Polat Life as we leave another year behind.

In this issue, we are proud to share with you our Polat Group Academy, which we have established with an investment of over 1 million Euros with the vision of contributing to the provision of qualified labor force to the sector and the development of qualified operators. With our Polat Grup Academy, we aim to provide potential operator candidates with theoretical and practical training within the scope of the operator training program within the framework of the İŞKUR On-the-Job Training Program, so that they can be brought into the sector and employed. At Polat Group Academy, we aim to train more than 100 operators per year and improve the competencies of the existing team. We opened our Polat Group Academy on Friday, March 15th with the participation of Dr. Masahiko Mori, CEO of DMG Mori, Vice President of Japan Machine Tool Manufacturers Association (JMTBA) and Member of the International Academy of Production Engineering (CIRP), one of the doyen names of the machine tools and metalworking machinery industry. We are very happy to have established our PG Academy, which we have wanted to realize for many years.

In this issue of Polat Life, we also feature Türkiye's largest decanter centrifuge, the SX 920, produced by Polat Makina, one of the subsidiaries of Polat Group Holding. First, we broke this record with the SX840, which we produced shortly before the SX 920. By producing the SX920, we broke both our own record and the Turkish record. This success is an important milestone not only for us, but also for the Turkish industry. This big step we have taken in the field of technology and engineering continues to bring our domestic production power to the world stage.

2024 was a year in which we took important steps in social benefit and sustainability, one of the core values of our company. Polat Makina was awarded with the Woman Welding Operator Training Program at the Social Benefit Awards organized by Dünya Newspaper.

In addition, as part of our sustainability vision, we implemented a major transformation with our rooftop solar energy system project at Polat Makina. With this 2,400 kWe (AC) capacity system, which was installed with an investment of approximately 2 million dollars, we aim to generate 4.9 million kWh of electricity annually. This project was a strong step towards our goal of reducing our carbon footprint by generating the energy we need from the sun. With our respect for nature, we aim to leave a cleaner and more sustainable world to future generations.



OLCAY POLAT

Chairman of Polat Group Holding

The meeting with members of the local press on the occasion of World Olive Tree Day on November 26, declared by UNESCO, was one of the important events of 2024 for us. Olives are a great value both for us and for the region where we operate. On this day, we met with valuable members of the press and once again remembered the contributions of the olive tree to our environment and economy. This value, which is at the foundations of our company, will continue to be an indispensable part of our sustainability goals.

Of course, behind all these achievements lies the devoted and meticulous efforts of our employees. Each and every member of Polat Group plays a major role in achieving our goals and making our achievements sustainable. With the strength and commitment of our teams, we are taking even more confident steps into the future.

Necdet Demir, who took part in the establishment phase of Polat Group Redüktör, one of our subsidiaries, and who has been the General Manager since 2004, when the company a legal entity, passed the flag to Erdal Deniz upon his retirement. On this occasion, I would like to take this opportunity to once again thank Necdet Demir for his devoted work and the value he has added to our company over the years. I would like to welcome Erdal Deniz to our team and wish him continued success.

As we step into 2025, we will continue with strong projects in strategic areas such as digitalization and sustainability. We aim to offer innovative solutions for our customers and business partners and increase our strength in global markets. With the contributions of every member of Polat Group, we are confident that we will take firm steps into the future.

I wish that the New Year brings us all health, happiness and success, and I hope you enjoy reading this issue.

Yours sincerely

Erdal Deniz, the new General Manager of Polat Group Redüktör, said that they will continue to grow with customer-oriented innovative products by focusing on efficiency in the upcoming period.

PIONEER OF INNOVATIONS AND CUSTOMER FOCUSED WILL CONTINUE TO BE

Polat Group Redüktör, a leading company in gearbox production, has appointed Erdal Deniz as its new General Manager, bringing over 21 years of industry experience. Deniz took over the rein with the retirement of Necdet Demir, who took part in the establishment phase of PGR and served as the general manager since 2004 when it became a legal entity.

Born in Belgium in 1980, Erdal Deniz graduated from Istanbul Technical University, Department of Mechanical Engineering and completed his MBA at Sabancı University. Having started his career at Hema Endüstri A.Ş., Mr. Deniz worked in managerial and senior management positions during his career and finally assumed the position of General Manager.



We talked to Erdal Deniz, who will direct the growth and innovation strategies of Polat Group Redüktör with his new position, about his future plans for Polat Life readers.

In your career, you have a wide range of experience as purchasing specialist to general manager. What experiences influenced and guided you the most in this process?

I started my career at HEMA Industry, where I had the chance to work in a wide variety of positions. I started my career as a purchasing specialist and worked as a "Lean Six Sigma" officer, quality assurance manager, plant manager, assistant general manager and general manager. In this process, my emphasis on teamwork, commitment to streamlining and my openness to innovation were the factors that carried me forward.

Throughout my career, I have worked in many different areas such as procurement, R&D, quality assurance, etc. This has given me the opportunity to understand the dynamics of the departments and to grasp the perspective of the teams working in those departments.

This experience in different departments has significantly improved my empathy, collaboration and effective communication skills. I took care to carry what I learned in each position to the next step and this knowledge shapes my leadership approach today.

You've recently joined Polat Group Redüktör as a fresh addition to the team. What kind of management style do you plan to implement?

I believe that being able to adapt to changing sectoral dynamics and innovations faster provides a great advantage in a competitive environment. In my management style, I adopt technology-oriented approaches, data-based decision-making and modern practices that will increase the motivation of teams. It is also very important for me to create a transparent communication environment within the company and to ensure that teams can share their ideas freely.

As General Manager, what will be PGR's strategic priorities in the coming period? What innovative projects do you plan to realize?

In the future of PGR, innovation, digital transformation and customer focus will remain as they have been until now. New projects that will enable the use of our products in different areas are also among our plans. We will continue to work to expand our product portfolio and remain the pioneer of innovation in the sector. We will also expand the use of lean production principles, Kaizen and Industry 4.0 practices to make our production processes even more efficient. In the coming period, we will continue our productivity-oriented growth with innovative products.

We see that you attach great importance to R&D in your career. What plans do you have to adapt PGR's products to different sectors?

R&D has always been a strategic focus for me. I believe that being an engineer and believing in continuous development plays a big role in this. At PGR, we will continue this approach and focus on innovative projects to ensure the use of our products in sectors where they are not available.

Knowledge on topics such as "Lean Six Sigma" and "Industry 4.0". How do you plan to integrate this expertise into PGR's digital transformation process?

"Lean Six Sigma" and "Industry 4.0" have taught me a lot about simplifying processes and increasing efficiency. I will, of course, actively use my expertise in the digital transformation process of PGR, which has an R&D culture that goes back to its founding. With my teammates, I aim to establish much more integrated and effective systems in both production processes and customer services.

You mentioned that you are a leader who attaches importance to the development and motivation of your employees. What steps do you plan to take in this direction at PGR?

Necdet Bey, who has contributed to every success of Polat Group Redüktör since its establishment, has also made great efforts to internalize the R&D culture with his visionary approach.



valuable and, of course, shows the value of our employees. It is possible to preserve this accumulation and carry it forward through training programs that will contribute to the professional and personal development of our employees. We will continue to attach importance to these training programs.

As a leader, how do you spend your time outside of work? How do you maintain a work-life balance?

For me, work-life balance is the key element that supports both work performance and personal happiness. Spending time with my family and exploring new places energizes me. I also enjoy reading books that will contribute to my personal development and following the innovations in technology. I believe that our Book Club, which I joined recently, will help nourish me in this sense. Playing sports is another source of motivation for me.

Rıza Korkut Özdemir, General Manager of Polat Group Holding, said that they implement sustainability policies in all areas

A BIG STEP FROM

POLAT MAKİNA FOR GREEN TRANSFORMATION SOLAR ENERGY SYSTEM

Polat Makina, with an investment of approximately 2 million dollars, 2400 kWe (AC) capacity- installed a solar energy system (SPP). Rıza Korkut Özdemir, General Manager of Polat Group Holding, stated that the SPP installed on the roof of the new factory Polat Makina, one of the group companies, has an annual electricity generation capacity of 4 million 900 thousand kWh and underlined that it is aimed to use all the electricity generated in the production facilities by 2027 with capacity increases.

With the investment incentive certificate of the Ministry of Industry and Technology, production at the SPP, which was established on the 28,500 square meter roof of the factory, started on October 18. With the commissioning of the facility, all of Polat Makina's annual electricity consumption of approximately 3 million KW will be met from solar energy. With the capacity increase of the factory, it is aimed to use all of the electricity generated in the production facilities by 2027.

Rıza Korkut Özdemir, General Manager of Polat Group Holding, said: "With this investment, which we realized with the vision of Polat Group Holding Founder and Honorary Chairman İbrahim Polat, Polat Group Holding Chairman Olcay Polat and other board members, we have taken a big step towards our green transformation goals. With our respect for nature, we feel responsible for leaving more sustainable production methods to future generations. We selected the locally produced solar panels used in the investment with the goal of high efficiency. The panels will also be cleaned autonomously by robots."

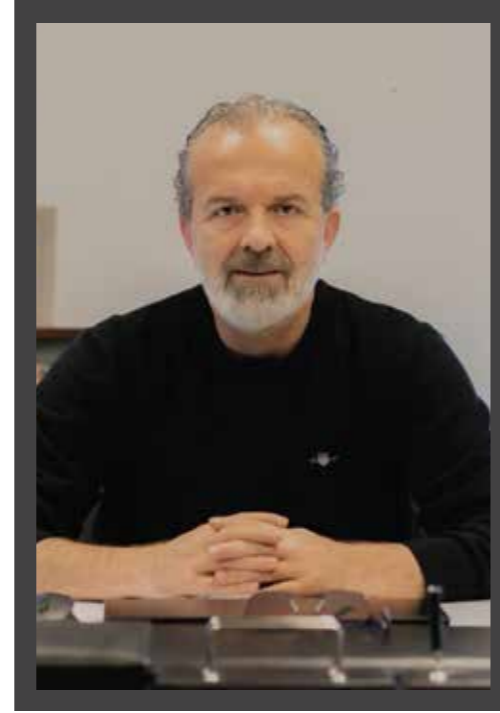

**Chairman of Polat Group Holding
Olcay Polat**

 Etik ve İtibar Derneği
Ethics & Reputation Society

 **TAİDER**
AİLE İŞLETMELERİ DERNEĞİ

BECAME A MEBER OF TEİD

Polat Group Holding became a new member of the Ethics and Reputation Association (TEİD), which has reached more than 220 members with the participation of Turkey's leading institutions and organizations.

Making a statement about becoming a member of TEİD, Olcay Polat, Chairman of our Board of Directors, said, "We find this membership very valuable in order to contribute to the implementation of ethical values in the sectors in which we operate and to carry ourselves further. We believe that this membership will make a significant contribution to our companies and all our stakeholders."

Operating since 2010, TEİD has more than 220 members.

POLAT GROUP HOLDING BECAME TAİDER MEMBER

Polat Group Holding became a new member of TAİDER Family Business Association, one of the most important non-governmental organizations in the business world, which operates to lead the continuity of family businesses in Turkey for generations. Mr. Olcay Polat, Chairman of the Board of Directors of Polat Group Holding, said: "We continue our journey in the business world started by our Founder and Honorary Chairman İbrahim Polat in 1978 by improving ourselves day by day. Today, with our group brands, we bring together manufacturers from all over the world with the technology we produce in Turkey. TAİDER leads family-owned companies with its mission of sustainability in businesses and its forward-looking vision. We are very happy to be a part of TAİDER."

Emphasizing that the visionary perspective of İbrahim Polat, the project's architect, inspires them to adopt more sustainable production methods, Özdemir stated, "We always set ambitious goals and are highly motivated to achieve them. We have realized our rooftop solar energy system in line with our sustainability vision. We have taken another important step in line with our green transformation goals by expanding sustainability to include not only the production stages but also the generation of the energy we need. We will continue our efforts to minimize our carbon footprint in all our business processes with determination."



**November 26, World Olive Tree Day,
we've met with the press at Polat Makina.**

WE WILL CONTINUE TO GROW WITH SUSTAINABLE AND INNOVATIVE TECHNOLOGIES



We came together with press representatives at the meeting we organized at Polat Makina on the occasion of World Olive Tree Day, which was declared by UNESCO on November 26.

At the meeting, where our Founder and Honorary President İbrahim Polat, Polat Makina General Manager Latif Mutlu Şahan Polat Group Holding General Manager Rıza Korkut Özdemir Financial Affairs Director Serkan Ersoy and Corporate Development and Human Resources Director Ahmet Doğan were also present, we gave information about our machines used in olive oil production, our company's activities and our future projects, and shared our sustainable production vision, olive oil technologies and future projects in detail. Our environmentally friendly production processes and our projects supporting women's employment attracted a lot of attention at the meeting.

Our Founder and Honorary President İbrahim Polat: "We Became a Global Power in 45 Countries in 46 Years"

İbrahim Polat, our Founder and Honorary President, made the opening speech of the meeting and told the 46-year success story of Polat Makina and emphasized how the company has grown in the global market. Polat added that they aim to expand into new markets and increase their global competitiveness in the coming period. İbrahim Polat reminded that the success story that started in Aydın in a small workshop of 4.5 square meters has turned into a global structure today and said, "We export our products to 45 different countries, especially Europe, the Middle East and America. Thanks to the devoted work of valuable talents at Polat Makina, we have reached our current position in a short period of 46 years. In the coming period, we aim to open up to new markets and further strengthen our global presence. In this process, we will continue to be a globally competitive player without compromising on customer satisfaction and quality."

Polat Makina General Manager Latif Mutlu Şahan: Sustainability and innovation are the cornerstones of our growth

In his speech at the meeting, our General Manager Latif Mutlu Şahan emphasized the importance we attach to our company's R&D studies and environmentally friendly production processes and stated that sustainability-oriented stable growth is among our main priorities. Şahan said, "With the R&D studies we carry out in our With 30000 square meters production facilities, we offer special solutions for every stage needed in olive oil production. Our technological superiority and We have a great prestige on a global scale with the importance we attach to quality. We continue our efforts to minimize our carbon footprint in all our business processes without slowing down."

Drawing attention to the importance of Aydın as a region, Şahan said, "The fact that the foundations of our company were laid in Aydın and that we have a deep-rooted history here encourages us to implement projects that add value to the region. In this context, we launched the Woman Welding Operator Training Program within the framework of our Connecting Power of Women project launched in 2023. The program is an important step towards supporting both women's employment and local development by contributing to the development of the region."

In 2024, Şahan underlined that they are progressing in parallel with their growth strategy and concluded by saying, "We aim to rise to a much more efficient position and increase customer satisfaction even further by implementing the projects we have planned for 2025."



POLAT MAKİNA

PROVIDING SKILLED WORKFORCE TO THE INDUSTRY WITH PG ACADEMY



Polat Makina, one of our group companies representing Turkey in 45 different countries of the world with the domestic technology machines it manufactures, established Polat Group Academy with an investment of over 1 million Euros. The academy aims to contribute to providing qualified workforce to the industry and developing skilled operators. Dr. Masahiko Mori, one of the doyen names of machine tools and metal processing machinery production, attended the opening ceremony of PG Academy.

In addition to the theoretical trainings, PG Academy participants will be provided with practical trainings in which machines and equipment are explained and demonstrated by master trainers, where they improve their manual skills by making trial production, and on-the-job trainings in which they use machines and equipment under the supervision of master trainers. At the end of the training program, candidates who will be subjected to theoretical and practical exams will be entitled to receive a certificate if they are successful in the exam and will be employed at Polat Makina.



PG ACADEMY WILL ALSO TRAIN EXISTING EMPLOYEES AND SUPPLIERS

PG Academy will also support the development of Polat Makina employees with mandatory vocational and technical trainings and personal development trainings in line with company goals and strategies. The development of the existing staff will be supported with technical trainings by analyzing their competencies and working on skill matrices. Training plans for the development of Polat Makina suppliers will also be made upon need and demand.

Industry veteran Dr. Masahiko Mori attended the opening

PG Academy was opened with a ceremony organized with the participation of our Founder and Honorary Chairman Ibrahim Polat, Chairman of the Board of Directors Olcay Polat, Vice Chairman of the Board of Directors Volkan Polat, General Manager of Polat Makina Latif Mutlu Şahan, General Manager of Polat Group Redüktör Necdet Demir and General Manager of Polat Group Holding Rıza Korkut Özdemir. Dr. Masahiko Mori, CEO of DMG Mori, Vice President of the Japan Machine Tool Builders Association (JMTBA) and a member of the International Academy of Production Engineering (CIRP), was also present at the opening ceremony.

Volkan Polat, Vice Chairman of the Board of Directors of Polat Makina said: "As Polat Makina, we offer world-class products and services to our customers in Turkey and around the world with our innovative approach, technological infrastructure and qualified human resources. We serve in an important sector with high added value. The way to make Turkey's name known worldwide in this sector is through experience and expertise. As Polat Makina, we very happy to establish the Polat Group Academy, which we have wanted to realize for many years. With the PG Academy, we aim both to recruit new qualified operators to the Polat Makina team and to provide quality and qualified labor force to the sector."



Following the opening ceremony, Dr. Masahiko Mori toured the PG Academy with our executives and received detailed information about the Academy and the activities to be carried out here.

WOMEN WELDERS OPERATORS ARE SIGNING OFF ON OUR MACHINES



Polat Makina, one of our subsidiaries, is taking a pioneering step in the sector with the trainings it has initiated to train women welding operators in line with its vision of contributing to gender equality and increasing female employment. While our female welding operators who have successfully completed their training have started to work, our goal is to increase the number of female employees by diversifying the program with different trainings.

Within the scope of the Welding Operator Training Program, women trainees who have never met welding equipment before are given theoretical and practical training on the use of welding equipment and Occupational Health and Safety by Polat Makina's experienced technical trainers at Astim Continuing Education Center. The first 8 female welding operators who successfully completed their training started to work at Polat Makina.

The company aims to increase the ratio of female employees to 15 percent by the end of 2025 by diversifying this program, which was initiated to contribute to gender equality, with different trainings.



Volkan Polat, Vice Chairman of the Board of Directors of Polat Makina, said: "In many countries today, women are also preferred as welding operators, CNC operators and electrical technicians.

Unfortunately, professions are still seen as male professions in our country. As Polat Makina, we are working to break this perception and help women to take a more active role in the business world and the sector by removing the obstacles in front of them. We are very excited to see that women welding operators, who have completed their training and started working within the company, have accomplished extremely successful works in a field they have never known before."



Latif Mutlu Şahan: Our support for women employment will continue.

Emphasizing that they believe in the power of women, **Polat Makina General Manager Latif Mutlu Şahan** said, "We attach great importance to women discovering their technical talents and becoming more involved in the industrial field. With the Women Welding Operator Training Program, we are very happy to increase women's employment, contribute to gender equality and enable more women to become active and productive in the industrial field. We will carry our training programs and activities for women's employment to different fields in the future in addition to welding operators."

SUSTAINABLE
BUSINESS
AWARDS
2024

SÜRDÜRÜLEBİLİR İŞ ÖDÜLLERİ

OUR WOMAN
WELDER TRAINING
PROGRAM WAS
SELECTED AS
A FINALIST IN THE
SUSTAINABLE
BUSINESS AWARDS.

WE WOULD LIKE TO
THANK ALL OUR TEAM
MEMBERS WHO CONTRIBUTED
TO THIS SUCCESS.



WE BELIEVED IN CONNECTING POWER OF WOMEN AND WE SUCCEEDED

Social Benefit Award to Polat Makina

The woman welding operator training program, which continues at Polat Group Academy in order to ensure more participation of women in the workforce, was deemed worthy of the "Social Benefit Award" by Dünya Newspaper. With the project we have implemented under the name "Connecting Power of Women", women who have never met a welding machine before are transformed into welding masters with the qualified training we provide.



Latif Mutlu Şahan, General Manager of Polat Makina, who received the award at the ceremony held at Hilton Maslak in Istanbul, said: "We continue to invest in line with our targets. But we are aware that the biggest investment is the investment in people. Eight of our female employees, who received specialized training in the first phase at Polat Group Academy, are now excelling in welding and leaving their mark on our machines. Within the scope of our 'Connecting Power of Women' project, we will increase the number of trained operators in the coming years and continue our vision of sustainable production. As a company that operates machines in almost every country where olives are grown and produces supercritical extraction systems that will have an important place in the production methods of the future, our future vision is based on sustainability. We aim to achieve this by increasing local employment. In the coming years, we will increase the number of female employees by providing trainings for local employment. Our contribution to the qualified labor force of our country will continue to increase."

After receiving the award, Şahan came together with the employees at Polat Makina the next day and announced this good news to the employees and presented this award to our Technical Trainer Hakan Aktepe and our female welders who made great efforts as a trainer in this program.



WE ARE PROUD

Our Woman Welder Training Program received an award at the **Social Benefit Awards** organized by Dünya Newspaper!

WE BELIEVE IN THE POWER OF WOMEN AND CONTINUE TO CREATE SOCIAL BENEFIT.

 **POLAT**®



POLAT MAKINA NEW VISION: AGILE TRANSFORMATION

Polat Makina came together with its employees from Türkiye and abroad at its annual strategy meeting with the theme of "Agile Transformation". At the meeting, company executives shared the company's 2024 targets and the new corporate vision and strategies built on the axis of "Agile Transformation" to achieve these targets and the new steps taken on this path.

Polat Makina shared its new corporate vision and strategies with its employees to carry its success further in 2024 at the annual strategy meeting themed "Agile Transformation" in Kuşadası. Polat Makina Vice Chairman of the Board of Directors Volkan Polat made the opening speech at the event where Polat Group Holding Chairman of the Board Olcay Polat, Polat Makina General Manager Latif Mutlu Şahan and managers from different business units shared information about the company's new period targets and the innovations realized in this context. Polat Makina aims to become much more efficient and competitive in 2024 and to increase customer satisfaction even further with the digital and operational transformation projects it has implemented.



Volkan Polat, Vice Chairman of the Board of Directors of Polat Makina, emphasized that Polat Makina, which is a worldwide brand today with its offices in Italy, Greece and Morocco as well as its offices in Istanbul and Aydın, aims to provide products and services at universal quality and standards with its qualified workforce and technological infrastructure. "It gives us great pride to come to this point in a short period of 45 years by working with young and valuable talents like you in our journey that we started in 1978 in a workshop of only 4.5 m2. As Polat Makina team, we are starting 2024 fully ready and motivated with the new steps we have taken. The way to be successful in the market and to achieve our goals in an intensely competitive environment that becomes more difficult every day is undoubtedly through agility. Our company's new vision, 'Agile Transformation', reflects our new philosophy that sees speed as the primary condition for success and growth in every line of business. In this new competitive environment, we can only succeed by being agile, being open and dynamic to innovations, adapting flexibly to market conditions and changes even under the most challenging conditions, constantly reviewing our strategies and rapidly changing them when necessary. The way to achieve this is first and foremost through strong and harmonious teamwork.

The support of you, our valuable colleagues, will be our biggest help as we move towards the goals we have set for this year. In 2024, I sincerely believe that we will reach our great goals very soon by working shoulder to shoulder in line with our new vision and principles."



Polat Makina General Manager Mutlu Şahan said, "Our new factory, which we moved to at the beginning of 2024, is not just a new building for us. This building also represents Polat Makina's new vision and philosophy that keeps pace with the new era. In line with this vision, we have accelerated our work in the field of digital transformation, which is indispensable to be more competitive today. We are taking important steps in this direction with the Manufacturing Execution System (MES), which increases efficiency by providing traceability and manageability to production processes, our room called Cockpit, which we use to obtain real-time data in our new factory, and the Digital Twin Project, which allows us to instantly monitor our factory and monitor the entire operation of the factory with andon systems in the Cockpit. In the scroll line, a key component of our operational transformation project, we successfully reduced the travel distance of scroll from 2.5 km to 250 meters and reduce production time from 66 days to 6 days through different improvements.



**Polat Group Holding Yönetim Kurulu Başkanı
Olcay Polat**



The record we broke with the **SX 840** decanter centrifuge, now we took it one step further with the **SX 920** decanter centrifuge

TÜRKİYE'S LARGEST

DECANTER CENTRIFUGE

FROM POLAT MAKİNA

SX 840



Polat Makina, which broke its own record and produced Turkey's largest decanter centrifuge SX 840 and introduced it to the sector in recent months, took its own record one step further and introduced SX 920 decanter centrifuge to the market. While SX 920 was designed to respond to the high capacity and efficiency needs of enterprises in the best way, it strengthened Polat Makina's position at the forefront of centrifuge production in Türkiye and in the world. Setting a new benchmark in performance, efficiency and technology, the SX920 makes operations shorter and more efficient.

Latif Mutlu ŞAHAN: We will further strengthen our position in the global market



Polat Makina General Manager Latif Mutlu Şahan stated that with the SX 920, Polat Makina has elevated the standards of sustainability, productivity, and efficiency even further. "Our previous model, the SX 840, became a key example that symbolized our exceptional engineering on a global scale," he said. Today, we continue to make a difference in the sector by breaking our own record and producing Turkey's largest screw diameter decanter centrifuge.

We push the boundaries of separation technology with our commitment to innovation, quality and customer satisfaction. Our SX 920 product, has a larger screw diameter and takes this record one step further, is the largest diameter decanter centrifuge produced in Turkey. With our SX 920 decanter, which will also strengthen our position in the global market, we aim to provide more efficiency, productivity and sustainability in indus-

The SX 920 decanter centrifuge, which has the largest screw diameter produced in Turkey with its 920 mm drum inner diameter, is designed to process input products in large capacities. Providing industrial enterprises with more efficiency and shorter processing times in their operational processes, the SX920 offers superior separation efficiency thanks to its advanced technology, enabling clearer liquid and drier solid output products.



SX 920

CARRYING TURKIYE'S FLAG IN

NORTH AFRICA WITH POLAT'S MARK

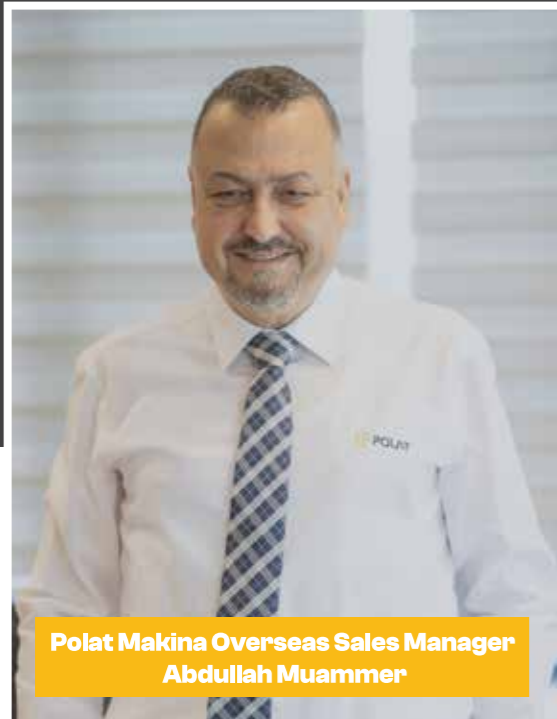

Polat Makina Overseas Sales Manager
Abdullah Muammer

Polat Makina Olive Processing Product Sales Manager Abdullah Muammer shared the process of Polat Makina's expansion into the North African market with Polat Life readers. Underlining that their priority is always customer satisfaction, Muammer explained the process that started with Tunisia, the reflections of the high customer satisfaction achieved here and how became a leader in many countries.

How did Polat Makina's expansion into the South African market like Tunisia start, can you tell us about this process?

When I started working, Polat Makina had already entered Tunisia and made sales. The market research we conducted in the following period also helped our process. As time passed, Tunisia became one of our biggest and most sold markets.

In fact, it was not very easy for us to enter the Tunisian market. When we decided to enter the Tunisian market in the early 2000s, one of the biggest problems we faced was a prejudice against industrial products produced in Türkiye. This prejudice was related to the quality of Turkish products against European products. At that time, there was a prejudice that the machines produced in Italy were ahead in olive oil production and we could see this very clearly in the attitudes of the producers who came to the fairs we attended.

We were witnessing people saying "When did the Turks become industrialists and machine manufacturers?" Therefore, we were not only promoting the machines produced by Polat Makina, but we were also the flagbearer of the products produced in Turkey. We worked to raise the image of Turkish products.

In order to gain a foothold in the market, we first brought our products to our critical customers in the critical regions we identified at more affordable prices than our competitors. We made every effort to establish trust in Turkish machinery. But more importantly, we stood behind every machine we produced. As you know, olive oil machines work during the olive season, but also work 24 hours a day, almost every day, during this short season. Therefore, it becomes very important to immediately intervene and resolve any problems that may arise. For this, it was necessary to establish a strong service and a strong spare parts network. We have achieved this.



All across the country, we stood by our customers within an hour and solved their problems, whether it was a breakdown or a need for spare parts during the olive season.

What are the most important considerations for entrepreneurs who want to buy a machine for processing olive?

For a new customer, this is a big investment. Therefore, before buying the machine, the customer does a serious research about the machine and the manufacturer. The first people he goes to those who are already using these machines. He even has his own olives pressed and asks other producers who have had their olives pressed about their satisfaction. He asks the machine owner questions about the operation of the machine and the support of the machine manufacturer.



We ensured customer satisfaction. We ensured the satisfaction of the olive pressing producer with the quality and quantity of the oil. **The most important reasons why our machines are preferred are high quality of the oil obtained and the amount of oil obtained.** Thus, Polat Makina started to spread and we reached our first target.

Our second goal was to prove that we were in a position to compete with our competitors, the European machine manufacturers. Our goal was to put Polat Makina's machines next to Italian machines and operate them under the same conditions. Thus, we wanted our customers and competitors to decide which machine was better and more efficient. We succeeded in this; our machines took place next to the Italian machines. This had a very serious impact on us. One manufacturer used the first machine we gave him in 2003 next to the Italian machine for two years and then sold the Italian machine and preferred our machines. This manufacturer is currently using five of our machines.

We have many examples like this. In this way, we have proven our product, quality and technical service. Currently, **more than 500 of our machines are actively used in Tunisia.** The most important issue behind this is that our after-sales service is very good; we have achieved a high level of customer satisfaction in after-sales service.

Why is after-sales service important?

During the olive season, for example, a machine with a capacity of 60 tons may be working outside the oil house. 500 tons of olives are waiting to be pressed. This means that dozens of producers wait in line to have their olives pressed. The most undesirable thing for an oil mill owner is to have a malfunction in such an environment.

Because you will lose your earnings, you will lose customers, and you will stress the waiting customers.

In such a situation, fast service and intervention to the machine within an hour will satisfy both the factory owner and the manufacturers waiting there.

The most important reason for our success is the quality and efficiency of the oil from our machines, as well as our customers' satisfaction after sales is that we stand by our people.

What the repercussions of the success in Tunisia?

The echo of our expansion into Tunisia was heard in North African countries and Italy, and even there, it was said that "Polat Makina is the leader in Tunisia". When our Algerian operations started, we heard the echoes of our successes in Tunisia, which of course made it easier for us to expand into new markets. Because we were giving our own customers in Tunisia as reference.

The owners of the machines spoke directly from their own experience about the efficiency and quality of the oil, the affordability of spare parts, the speed and quality of after-sales service.

We have narrowed the space of Italian brands in the Tunisian market and have become the leader. Of course, we will maintain this leadership by continuing to struggle and develop continuously. The place of Italian brands in Tunisia has shrunk, but brands from Germany have started to enter the market. Now we will struggle against the image of "German quality".

We need to constantly do better and become more efficient. We are improving, but our competitors are also improving themselves.

In order to remain the leader, we need to continuously improve ourselves not only in sales and marketing but also in quality and efficiency. At the moment, our serious competitors are the Germans.

What do your customers care about? For example, what are the dynamics that determine the way they do business in South African countries?

Our customer potential is completely based on trust. If they trust you, they will be your customer, if they don't trust you, they will never come together with you.

Therefore, those representing the company need to know the customs and traditions of the customer and understand how to gain their trust.

Trust comes before the capabilities of the machine. Our success is based on the trustworthy history of our company, the stance of our company representatives who always prioritize trust, and the production of our machines with superior technology and engineering. For this reason, the top priority for our Founder and Honorary President Mr. Ibrahim Polat and our entire senior management is to protect and maintain this trust.

For example, a decanter is half of a machine. If there is a problem with the decanter of a machine, Mr. Ibrahim wanted it to be replaced without even thinking. The important thing here is customer satisfaction and our management has supported us in these matters. Currently, we carry the Polat Makina flag in almost every country where olives are produced with our own quality understanding.

POLAT MAKINA IS PART OF LIFE



We provide all the necessary equipment for your **olive oil production process**, along with modular designs adaptable to capacity growth, seamlessly integrating into your operations.

Centrifuge & Extraction Technologies

● www.polatas.com.tr ● +90 850 255 1978



Polat Group Redüktör Production Manager Ahmet Keçeci:
We are among the few companies capable of mass
producing Cycloid Gear Units

PGR SIGNATURE ON
CYCLOIDAL GEAR UNITS

Polat Group Redüktör, one of our subsidiaries, continues to be one of the leading companies in the sector with the production of cycloid gear units, which find a wide range of use in many industrial applications with their advantages.

Our cycloid gear units production project, which was included within the scope of the Movement Program of Ministry of Industry and Technology, is yielding results fruit with foreign currency inflow to Turkey.

PGR Production Manager Ahmet Keçeci stated that within the scope of the program, special studies on heat treatment, investments in processing and measurement methods were carried out at PGR, and informed that workflow improvements were made in production with these investments. In addition, our cycloid gearboxes, which make a difference with less vibration and low noise compared to conventional gearboxes, are manufactured in high quality and offer our customers reliability and long-term use.

Stating that cycloid gearboxes, which can offer high bond ratios in a single stage unlike traditional gearboxes, stand out with their potential to be used in complex and special applications. Keçeci said, "Cycloid gearboxes, which can be used more safely in irregular load environments, offer the best solution for space-constrained jobs with their compact structure. Our cycloid gearboxes offer cost advantages and high efficiency to businesses with low energy consumption. In addition, we offer our customers reliability and long service life as we manufacture our high quality gearboxes, which make a difference with less vibration and low noise compared to conventional gearboxes, in high quality."



Our target is robotic control units

Reminding that cycloid gearboxes are preferred in a wide range of industrial applications, Keçeci said that the next target with the new investments at PGR is robotic control units. Stating that they improve their production processes day by day in parallel with the demands and needs of the robotics industry, Keçeci said, "We are reaping the rewards of our focus on R&D by developing high-tech products. Always aiming for the better, we continue to work towards the needs of not only today but also tomorrow. Because our company culture is based on always producing high value-added products."

Stating that they started to supply products to sectors such as automotive with the renewal of the machine park and capacity increase, Keçeci said, "We products not only for these sectors, but also for companies from different sectors with our OEM (Original Product Manufacturer) production. We are also able to fulfill these demands when our customers request

your value
 adding partner...

PGSOLUTIONS

Which is the most
profitable solutions
 for your dairy plant?

LET'S DECIDE TOGETHER

With a free exploration service, **PG Solutions's** expert engineers are waiting for you.



PG Solutions Customer Services

0850 255 1978

*All machines and their parts in the image are representative. They do not reflect the reality.

www.pgsolutions.com.tr



Scan the QR code to discover the PG Solutions's world.

AIYDIN organized at Adnan Menderes University: We took part in the Technology in the Age of AI Summit!

In the Engineering Technologies session, Mehmet Bilir, Decanter R&D and Product Development Manager of Polat Makina, one of our group companies, gave a speech on Centrifuge Technologies and Applications.



Our Human Resources team also conducted an interview simulation with young talents. Important information was shared about the tricks to be considered in the interview processes and how to have an effective interview. It is a great pleasure for us to contribute to the career journeys of young people.

We would like to thank everyone who contributed to the event. We will continue to support future technologies and young talents.

Adnan Menderes University (ADU) Technology and Innovation Community Visited Our Factories



In the technical trip organized by Adnan Menderes University Technology and Innovation Society, we hosted the engineers of the future at the factories of our group companies PGR and Polat Makina.

Hakan Yavuz, Machining Executive at our PGR factory, and Metehan Orhan, Assembly Executive at our Polat Makina factory, introduced our companies' innovative production processes and technology-based solutions to the students.

It is a privilege for us to guide the engineers of the future. We look forward to coming together again in innovative projects.

We Met with Students at ADU

Within the scope of Adnan Menderes University - Industry cooperation, GEKA (South Aegean Development Agency) brought together the important industrial organizations of Aydın with students at Adnan Menderes University within the framework of the cooperation project on Digital Transformation, innovation and ERP. At this meeting, Ahmet Doğan, our Human Resources and Corporate Development Director, and Hüsnü Özden, our Information Technology Manager, shed light on Polat Group and its digital transformation projects. Within the scope of the project carried out by GEKA, engineering students will be employed part-time by industrial organizations. As Polat Group, we believe that the future will develop with young people and we are proud to support this project carried out by GEKA.



Our book club has been founded

We are excited to formalize our passion for books!

In our first meeting, we came together with our employees, our General Manager Rıza Korkut Özdemir and Latif Mutlu Şahan, General Manager of Polat Makina, one of our group companies, and stepped into the magical world of books together. We determined the first book of our club together with all our members and once again felt power of books and the joy that multiplies as we share.

We can't wait to explore new worlds in exciting pages.

Polat Technic 2024 Vision Meeting



Polat Technic, the After Sales Service Team of Polat Makina, one of our group companies, held its annual Strategy and Vision meeting this year at Aydın Anemon Hotel under the leadership of Polat Technic Group Manager Özgür Kara.

The meeting started with Polat Makina General Manager Latif Mutlu Şahan's speech emphasizing agility and digitalization at every point, and continued with our Technical Assistant General Manager Engin Aydınoğlu sharing information about 2024 targets and general strategies.

In this interactive meeting where we worked intensively on increasing customer satisfaction, digitalization and agility, we look forward to moving forward even stronger in line with our goals!

Kaizen Awards Recognized

Polat Makina, one of our group companies, prioritises the principles of continuous improvement and innovation, and continues to reward suggestions from its employees. The Kaizen Award Ceremony, which we organized with great excitement, started with the opening speech of Polat Makina Technical Assistant General Manager Engin Aydınoğlu and continued with the presentation of the awards. We will continue to listen to and value the ideas of our employees and celebrate their contribution to our business.



Personal Data Protection Law Training was Provided to Our Employees from Herdem Attorney Consultancy

Personal Data Protection Law training was provided to our employees under the consultancy of Herdem Attorneys. At the end of the training, our employees started to work to complete the actions assigned regarding the Personal Data Protection Law processes in their units.



Theater Ticket Surprise for Our Employees

We presented tickets to our employees for Moliere's play "The Foolishness of Politeness" performed by the Izmir Amateur Levantine Theater. All proceeds from the play will be donated to the restoration works of Casa Italia by the Izmir Amateur Levantine Theater. We are proud to contribute to this meaningful project and to provide our employees with pleasant moments!



Lean Transformation at Polat Makina Started at a Great Speed

Polat Makina, one of our group companies, took the first step in its Lean Transformation journey with the kick off meeting held with the participation of all unit representatives. The event started with the opening speech of Latif Mutlu Şahan, General Manager of Polat Makina, and continued with the training given by consultant Can Yükselen on Lean Thinking, Lean Production and Lean Leadership.

While mapping our Lean Transformation journey, we strengthened our practical skills with simulation training. As we move towards a future focused on efficiency, quality and customer satisfaction that Lean Transformation will bring, we are getting stronger with every step.



Hakan Ülken, President of Aydın Chamber of Commerce, Visited Our Field

We hosted Hakan Ülken, President of Aydın Chamber of Commerce and Coşkun Cerit, Chairman of the Assembly of Aydın Chamber of Commerce at our site. Our Founder and Honorary President İbrahim Polat, Chairman of the Board of Directors Olcay Polat, General Manager of Polat Group Holding Rıza Korkut Özdemir and General Manager of Polat Makina Latif Mutlu Şahan accompanied the visit.

During the visit, our production areas were visited, information was given about our technology and innovation-oriented approach and production processes, and evaluations were made on the industrial potential of Aydın.

We would like to thank Hakan Ülken and the Aydın Chamber of Commerce for their kind visit.



Aydın Tax Office President Serdar Şahin and Güzelhisar Tax Office Director Mustafa Atalay Visit Our Company

Aydın Tax Office President Serdar Şahin and Güzelhisar Tax Office Manager Mustafa Atalay visited the new factory of Polat Makina. Our Founder and Honorary Chairman İbrahim Polat, Chairman of the Board of Directors Olcay Polat and Polat Group Holding General Manager Rıza Korkut Özdemir accompanied the visit. We would like to thank Şahin and Atalay for their valuable visit.



We hosted ADU Engineering Faculty Management

We hosted Prof. Dr. Hilal Şahin Nadeem, Deputy Dean of Aydın Adnan Menderes University Faculty of Engineering, and the department heads of the faculty at Polat Makina and Polat Group Redüktör factories.

We held a comprehensive information meeting at Polat Makina on our Supercritical Fluid Extraction systems, which constituted the main focus of interest of the delegation, and then we toured our factory and introduced our system on site. At Polat Group Redüktör factory, we provided information about our production processes.

İbrahim Polat, Founder and Honorary Chairman, Olcay Polat, Chairman of the Board of Directors, Rıza Korkut Özdemir, General Manager of Polat Group Holding Latif Mutlu Şahan General Manager of Polat Makina and Necdet Demir General Manager of Polat Group Redüktör accompanied the visit.



iŞKUR Aydın Provincial Director Rahmi Terzi Visits Polat Makina

Rahmi Terzi, Provincial Director of Aydın Labor and Employment Agency (iŞKUR), visited Polat Makina, one of our subsidiaries. During the visit, Terzi came together with the white and blue collar employees who were trained or continue their training within the scope of the "On-the-Job Training Program" between iŞKUR and Polat Makina. Latif Mutlu Şahan, General Manager of Polat Makina, accompanied Terzi during the visit and stated that they continue to grow with young employees and that they are pleased to bring qualified employees to the sector by working together with iŞKUR.



Industrialists from Denizli Visited Our Factories

Members of the Machinery Manufacturing Vocational Group of Denizli Chamber of Industry and members of MAKSiAD (Association of Machinery Industrialist Business People) Denizli Branch visited the new factory of Polat Makina, one of our group companies, and PGR ASTİM and PGR Umurlu factories. In addition to our company executives, our Founder and Honorary President İbrahim Polat accompanied the visit.



We Sponsored International Turkey Crane Summit

As Polat Group Redüktör, we were the silver sponsor of the International Turkey Crane Summit held in Istanbul on October 23, 2024. The summit provided data to determine the national and global position, importance and share of the electric crane manufacturing sector within the crane and machinery manufacturing ecosystem. In addition, predictions were made about the future of the sector with the resulting data.



We hosted our visitors at Polat Makina as part of the Target Africa International Visit Program

Within the scope of the Target Africa International Visit Program organized by the Food, Agriculture and Livestock Producers Association, we hosted important guests at Polat Makina's factory. The Ambassador of Togo to Ankara, mayors from Nigeria, the advisor of the French President, ITEF President M. Zeki Güvercin, Association President Tevfik Fikret Koca and many other valuable guests were with us to get information about our products and our company.



We Stand by Olive Oil Producers with Our Trainings

In cooperation with Aydın Commodity Exchange, we provided two days of training to our olive oil producers, one day theoretical and one day practical.

On the first day of the training, theoretical topics such as olive-olive oil general information, olive oil quality parameters and quality olive oil production process were explained by our R&D unit at Aydın Commodity Exchange. The next day, Polat Technic, our after-sales service unit, organized a practical training for our producers at our factory. During the practical training, topics such as increasing the efficiency of production processes and maximizing olive oil quality were discussed.



Polat Group Holding is a Signatory to Global Compact and is Committed to Supporting the 10 Principles of the UN Global Compact.

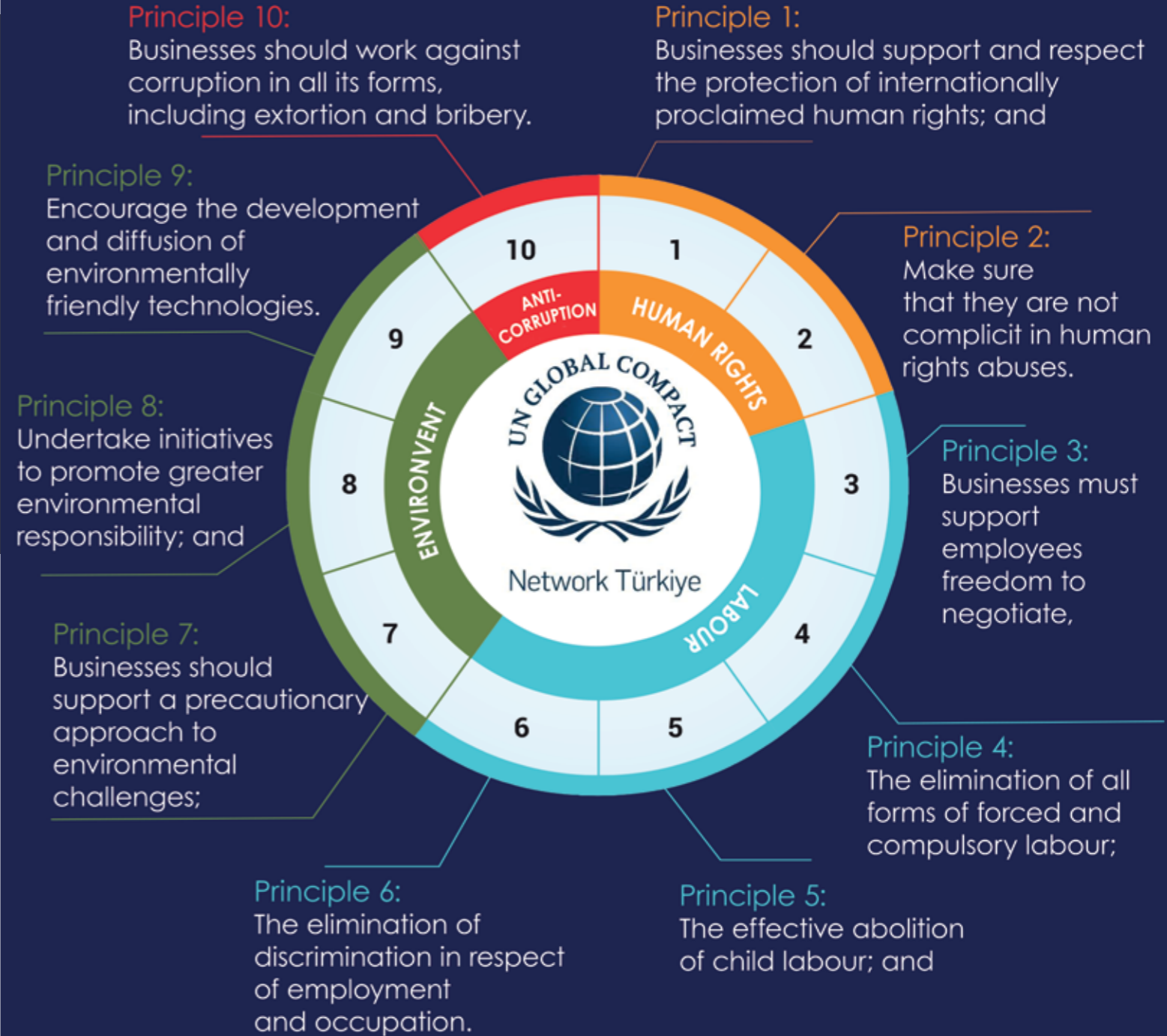

PGR 2024 FAIRS

HANNOVER MESSE 2024

As Polat Group Redüktör, we were at the Hannover Messe 2024 Fair, one of the world's leading industrial technology fairs, which was held in Germany between April 22-26, 2024. At the fair, we brought together the participants with our gearboxes produced with the latest technology and our solutions that can meet the special demands of customers.



IDMA 2024

As Polat Group Redüktör, we took part in IDMA 2024 Fair held at Istanbul Expo Center between May 2 -4, 2024 and exhibited our latest innovative solutions for flour, feed, corn, semolina, rice, bulgur milling machines and bakery, pastry, biscuit technologies sectors.



IFAT MUNIH 2024

As Polat Group Redüktör; we exhibited our latest products and technologies by participating in IFAT Munich 2024 Fair, which is the world's leading trade fair in the field of water, sewage, waste and raw material management and held in Germany between 13-17 May 2024. IFAT was the meeting point of innovative solutions in the sector with thousands of visitors and exhibitors this year. At IFAT, which has been organized since 1966 and has become a global network in the field of environmental technologies, our advanced technology gearbox solutions attracted great interest.



WIN EURASIA 2024

Win Eurasia 2024, the meeting point of the industrial and manufacturing sectors, was held in Istanbul on June 5-8. As Polat Group Redüktör, we introduced our new products and technologies at the fair. While 662 exhibitors from 16 countries took part in Win Eurasia 2024, the fair was a big event with visitors from 102 countries.



PRS Plastics Recycling Show Europe 2024

As Polat Group Redüktör, we introduced our gearboxes and technology used in the plastic recycling industry at the PRS Plastics Recycling Show Europe 2024 event held in Amsterdam between June 19-20, 2024. PRS Plastics Recycling Show Europe 2024, the meeting point of the plastics recycling and environmentally friendly applications sectors, brought together the leading companies of the sector and their innovative solutions this year.



SOLIDS & RECYCLING-TECHNIK

As Polat Group Redüktör, we participated in the Solids & Recycling-Technik Fair held in Dortmund, Germany on October 9-10, 2024 with our sectoral solutions.



As Polat Group Redüktör, we had the opportunity to come together with the leading companies of these two sectors and show our innovative solutions at the fair, which is the meeting point of the industrial and manufacturing sectors.

EUROTIER 2024

As Polat Group Redüktör, we also took our place at EuroTier 2024 Fair held in Hannover Fairground in Germany on November 12-15.

EuroTier, one of the most important international trade fairs for professional animal husbandry and management, offered a comprehensive overview of innovations and standards set as the leading innovation platform for the global animal production industry. Developments in cattle and poultry breeding were discussed in detail.



PTC ASIA 2024

We participated in the PTC Asia 2024 Power Transmission and Control International Trade Fair held at Shanghai New International Expo Center in China on November 5-8.

More than 1700 exhibitors part in the exhibition, which was held on an area of more than 100 thousand square meters this year. Welcoming more than 150 thousand visitors, PTC ASIA 2024 Exhibition showcased products and services in the fields of hydraulics, pneumatics, seals, gears, motors, chains, belts, bearings, springs and industrial supply.

POLAT MAKINA 2024 FAIRS

SIAM 2024

As Polat Makina, we participated in SIAM, Africa's largest agricultural fair held in Meknes, Morocco on April 22-28, 2024. We exhibited our processing units.



IFAT Munich 2024 Munich, Germany

As Polat Makina, we participated in IFAR Munich, one of the world's largest fairs in the field of environmental technologies and waste management, which took in Munich, Germany on May 13-17, 2024, and exhibited our centrifuge technologies for environmental and wastewater treatment solutions at this biennial fair.



SMA MEDFOOD Sfax, Tunisia

The rich gastronomic culture of the region and innovative food processing techniques were exhibited at the SMA MEDFOOD fair, which focused on Mediterranean food products and processing technologies and took place in Sfax, Tunisia on May 15-19, 2024. As Polat Makina, the fair, where we introduced our olive oil production lines, became important meeting point for local and international participants.

Olivtech 2024 – Izmir, Turkiye

As Polat Makina, we participated in the Olivtech fair held in Izmir on May 23,25, where olives, olive oil, dairy products, wine and other local food products were exhibited. We introduced our olive oil processing technologies and centrifuge systems at the fair. Olivtech, an unmissable fair for those who want to discover the rich agricultural heritage and flavors of the Aegean Region, offered the opportunity to learn about the latest innovations and products and to establish business contacts.



Beauty Istanbul 2024 – Istanbul, Turkiye

Polat Makina Supercritical Fluid Extraction Systems team took its place at Beauty Istanbul Fair held on October 2-3-4.

During the fair, we provided visitors with comprehensive information about our supercritical fluid extraction systems and introduced our innovative technologies and application areas.



WHICH OUR SIGNATURE IS PRESENT

 **TUNISIA** 

Polat Makina has been operating in Tunisia, one of the most olive producing countries in the world, for 24 years. Here you can find our recommendations for those who will visit Tunisia.

• **Capital Tunisia** •

Tunisia is divided into two parts, the Medina and the Ville Nouvelle (New City), and there are many places to see such as museums, mosques, parks and churches. For this reason, you can spend three days to visit the city. The Old City (Medina), a UNESCO Heritage, was built between the 12th and 16th centuries, when the country came under Arab control. One of the most important cities in the Islamic world at the time, today it is a popular destination for those who want to get lost in its narrow and tangled streets and buy traditional products.

Dar Ben Abdallah Museum

Located in the Medina district of the city and built in the 18th century, Dar Ben Abdallah Palace is now used as an ethnography museum. The well-preserved museum is a must-see for those curious about the details of Tunisian history and North African culture. The museum is open every day of the week and can be visited between 10:00-16:00.

Bardo Museum

The Bardo Museum, Tunisia's most important archaeological museum, was the palace of the Ottoman governor Ali Pasha until the French occupation. The palace, which was into a museum during the occupation, exhibits rare pieces from the Carthaginian and Roman periods. We recommend those who have seen the Zeugma Mosaic Museum, where the mosaics found in the ancient city of Zeugma are exhibited, and the Hatay Mosaic Museum to have the privilege of seeing the Bardo Museum. Home to 2,000-year-old mosaics, the museum is closed on Mondays. It can be visited between 09:00-17:00 on other days.

Sidi Bou Said

Half an hour from the capital Tunis, Sidi Bou Said welcomes its guests with a completely different character and style from other corners of Tunisia. Sidi Bou Said, where whitewashed houses gain identity with their blue doors and windows, reflects the atmosphere of a charming Mediterranean town with the flowers hanging from the walls of the houses.

Carthage Ancient City

The city of General Hannibal, considered one of the greatest military geniuses of all time, Carthage dates to 800 BC. Carthage, which means "new city" in Phoenician, can be reached in about half an hour from the capital. A major commercial power before Rome, Carthage is a UNESCO Cultural Heritage Site due to its archaeological remains and historical importance.

Zeytune Mosque

The Zeytune Mosque is one of the oldest mosques in Africa. The mosque, which has nine entrances, is spread over an area of 5 thousand square meters. Named "Zeytune" because it was built on a hill with olive groves in the capital Tunis, the historic mosque is one of the first universities in the world. Built at the end of the 7th century, the mosque gained its current form with the additions and renovations in the following periods. The mosque, whose rectangular minaret is one of the first elements that catches the eye, reflects Arab architectural elements with its authentic style. The Zeytune Mosque is open to tourists every day only from 08.00 to 11.30.



Matmâta

Matmâta, located in Jabal Dahar in southern Tunisia, is an "underground village". In addition to this interesting feature, Matmâta is also one of the places where the "Star Wars" movie series was filmed. The 1977 movie Star Wars: Episode IV -A New Hope was filmed in the city, which still houses the sets of the movie. Mat- mâta is one of the most popular destinations for Star Wars fans who want to see the filming location and see where Luke Skywalker, one of the main characters of the story, spent his youth. If you want to see Luke Skywalker's home in the movie and sit at the table where he ate, you should definitely visit Mat- mâta.

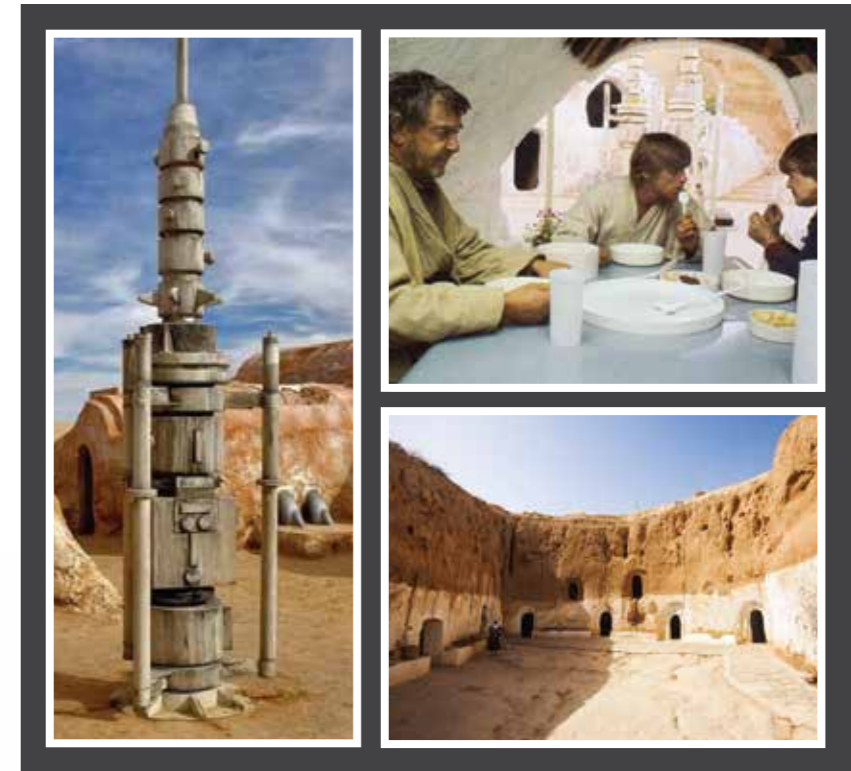

Great Sahara Desert

One of the must-experiences when visiting Tunisia is, of course, seeing the Great Sahara Desert. The Great Sahara Desert covers an area of 9 million square kilometers in the north of Africa, separating the middle and north of the continent, and is the largest hot desert in the world. Those who want to organize a touristic trip in the Great Sahara Desert, which covers about 30 percent of the African continent, can sail into the desert on camels, horses or four-wheel-drive all-terrain vehicles.



• Gastronomy •

Harissa Sauce

Harissa sauce, which is prepared with the basic ingredients of hot red pepper, olive oil, coriander and garlic and can be diversified by adding the desired baha- rats, is almost the national sauce of Tunisia. The diversity to be obtained with the ingredients to be added allows it to be added to many dishes or consumed with meals.



Kuskus

Tunisian cuisine is a combination of Mediterranean and classical Arabic cuisines. The most important local dish in the country is couscous and it is quite famous. Flavored with harissa sauce, this pastry is served with side dishes such as meat, chicken, potatoes or carrots.



Ojja

Ojja is a stewed meat dish flavored with harissa, egg, tomato, olive oil and garlic. One of the most frequently consumed dishes, ojja can also be made with small sausages.



Kafta

If you miss your home in Turkey while you are in Tunisia, you can order kafta. Kafta, which is quite similar to meatballs in Turkey, is made with minced meat, spices and chopped onions. The difference from meatballs comes from the spices used in it.



inside out

Turning everything about gear units



Industrial Size Cycloid Gear Units

New PCD Series



PGR[®]
DRIVE TECHNOLOGIES

www.pgr.com.tr

THE MAESTRO WHO REGULATES THE RHYTHM OF THE GEAR BOXES

The power that beats at the heart of a machine is hidden here, between the finely machined gears of gearboxes. They are not just mechanical components; they are works of art, masterfully designed by engineering, blending functionality and elegance. Each one works like a maestro masterfully conducting a complex symphony.

Gearboxes machines work in harmony, balancing speeds and transmitting torque in a delicate dance, without feeling the weight of load that needs to be carried. Whichever type you choose - helical, bevel gear units or planet gear units each one tells a unique story.

Helical gear units compose music with high efficiency and silence; bevel gearboxes show power in tight spaces; planet gear units are a shining star with speed and torque in industrial areas.

PGR's gearboxes aim for the ultimate in durability and quality. They offer not only performance but also aesthetic value. Gearbox housings are shaped like sculptures from the hands of an artist. Each piece of material is carefully selected and processed with the latest technology.

Which gearbox should you choose? Actually, the answer to this question is specific to your needs. But remember this: Your choice is not only a technical decision, but also a choice that will give your machines soul.

The PGR is not only a mechanical, but also an engineering masterpiece. In the sharpness of each gear and the robustness of each body, you feel the touch of a dedicated craftsman.

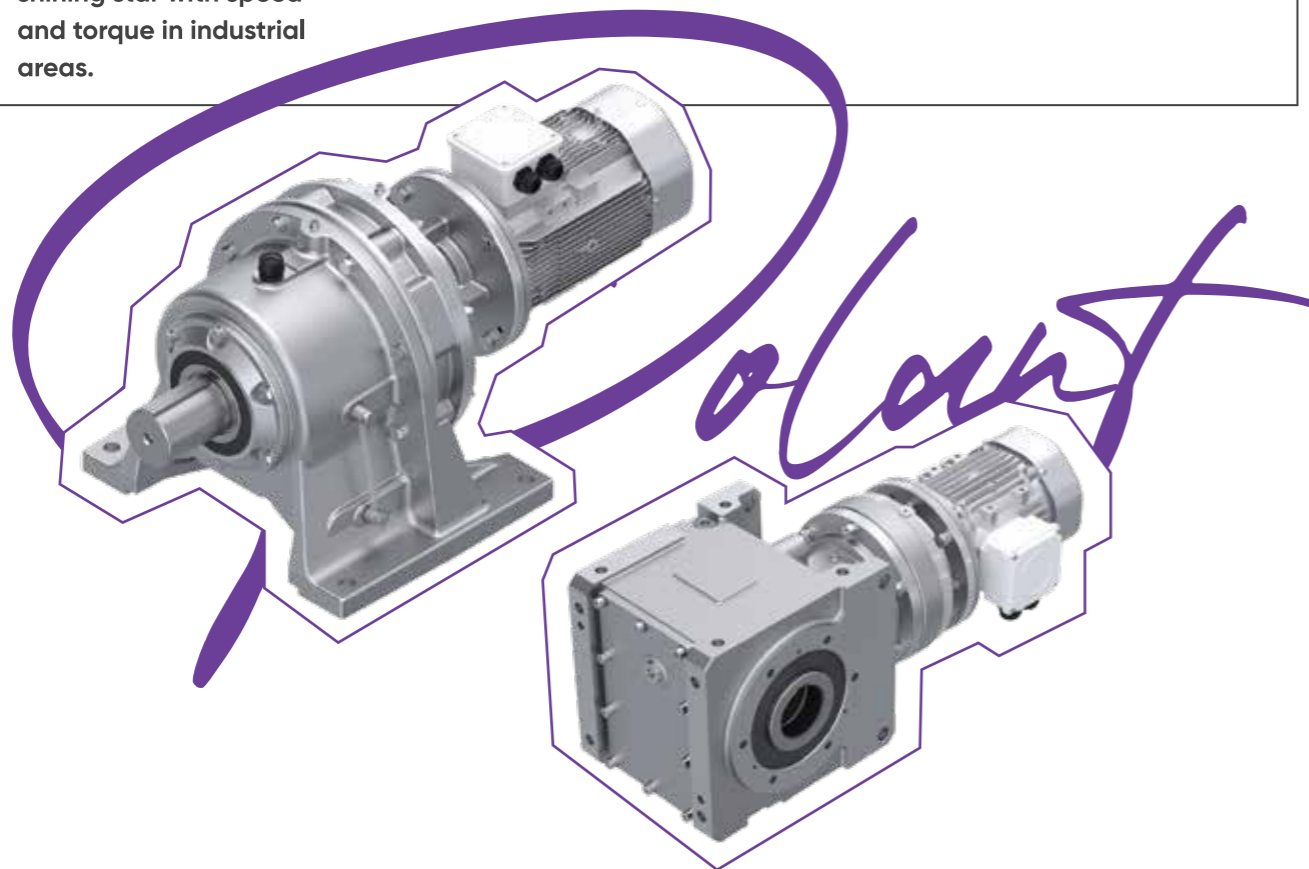

What are the issues to be considered in gearbox selection?

Application load, required torque and operating speed are the main criteria for selecting the right gearbox. Gearboxes with high torque and heavy load carrying capacity also provide high performance and durability. In gearbox selection, the speed range in which the gearbox will operate is important as it will ensure efficient and accurate operation of the machines. The importance of energy efficiency in reducing operating costs is undeniable. With the appropriate gearbox selection, the efficiency obtained from the energy used can be increased. While the installation and compatibility of gearboxes play an important role in the design and layout of machines, the ability to operate in environmental factors makes durability and protection features important, especially for gearboxes that will operate in harsh conditions.

Which gearbox?

Gearboxes with different designs such as Helical gear units, planet gear units, helical worm gear units, industrial type gear units and feeder mixer drives each offer different advantages. When selecting a gearbox, it is important to check whether it meets the criteria in the performance comparisons and choose the most suitable one. Helical gear units provide high efficiency and silence and are generally ideal for areas where high torque is required at low speed. Planet gear units offer an ideal solution as a drive system for conveyors used for heavy load transfer, where the movement must be directed 90 degrees. If high precision and durability are required, planet gear units should be preferred as they are perfectly suited to applications requiring precise speed control. Planet gear units have proven their success in industrial applications requiring high torque and speed. Cycloid gearboxes offer precise motion control and maximum durability with low noise and minimal maintenance, ensuring long-term productivity in industrial applications.

How to choose the needed gear boxes?

QR code below, you can select the gearbox you need and access technical details.



GearBoxSelection

What is gear quality?

The actual evolute, helix and pitch values of the gear correspond to theoretical values specified in DIN3961. According to the DIN norm, gear quality is defined from 1 to 12. 1 represents the highest quality and 12 represents the lowest quality. The gears produced by PGR are of quality 6. Thanks to the high-tech grinding machines at PGR, even better grades can be produced.

Why are bronze gears used in worm gearboxes?

The worm screw is made of cementation steel 16MnCr5 (1.7131) and the wheel gear is made of bronze CuSn12Ni2-C (CC484K) alloy. In worm gearboxes, the efficiency is lower than other gearboxes because the worm and the counter gear transmit motion by sliding on each other. Heat generation in the system is also high due to the sliding motion. For this reason, when selecting gear materials, the material pair with the lowest coefficient of friction between them is selected and in order to facilitate the removal of the heat generated, attention is paid to the appropriate design in the body design and attention is paid to the selection of materials, equipment and oil used.

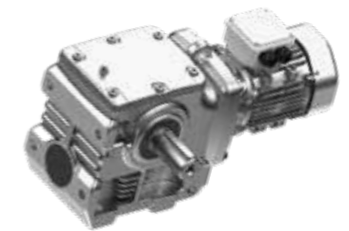

What are the materials used in gearbox housings?

Gearbox housings produced by PGR are made of cast iron (Cast Iron (GG20-22-30)) and Ductile Iron (GGG40-50-60) materials by various casting methods. Aluminum parts are produced by aluminum injection method.

What are the tests applied to gearboxes?

At PGR, inspections and tests are carried out at each stage of gearbox manufacturing. These are

- After the material has been procured: Material spectral analysis and metallographic analysis
- After the casting process: Spectral analysis
- Heat treatment: Hardness and hardness depth measurement
- In gears and housings: Geo-metric measurements with 3D measuring machines
- Final control: Sound intensity measurement, reducer output speed, motor voltage and current controls.

Which oils are used in gearboxes?

Synthetic oil is used in planet and worm gearboxes produced by PGR, while mineral oil is used in helical and bevel gearboxes.

MOVIE & BOOK RECOMMENDATIONS



Let the seas see adventure: Moana 2

Trying to prove herself as a master explorer, Moana sets out on a daring mission after receiving an unexpected call from her ancestors. Moana's story now evolves into completing the unfinished quest of her ancestors. In this quest, Moana embarks on completely different adventure in the vast seas of Oceania, a dangerous place where no one can steer anymore. Produced by Walt Disney Animation Studios, Moana 2 is directed by David G. Derrick Jr., Jason Hand and Dana Ledoux Miller.

Our Book Club Suggests!

Midnight Library – Matt Haig

Imagine a place where all what ifs are erased from your mind. If you had the chance to make amends for your mistakes and regrets, would you handle certain situations differently? Nora Seed finds herself in the vast and seemingly endless Midnight Library and realizes that she has a chance to make amends for all her regrets so far. The books in the Midnight Library give Nora the right to try on other lives she could have lived, and she gets the chance to see how her life would have turned out if she had made different choices. Check out this novel if you want to take a long and magical journey with Nora through regrets, what-ifs and possibilities.



Sumerian Ludingirra – Muazzez İlimiye Çığ

This work, which sheds light on the daily life and rich culture of the Sumerians, will allow you to witness that period through the language of Ludingirra of Sumer. Written with Muazzez İlimiye Çığ's powerful pen, this work will take you into the depths of history.

Resonance Law– Pierre Franckh

In this book, author Franckh shows how to eliminate internal and external influences that have the potential to block aspirations, how to have a positive vision of goals, how to establish a strong resonance field, and how to achieve the desired changes through the power of thought and feeling.



Polat Group Redüktör'de Üst Düzey Atama



Polat Group Redüktör'de Üst Düzey Atama. Mustafa Özalp, Polat Group Redüktör'de Üst Düzey Atama. Mustafa Özalp, Polat Group Redüktör'de Üst Düzey Atama.

Nasıl Bir Ekonomi | 27.11.2024

Nasıl Bir Ekonomi | 27.11.2024. Nasıl Bir Ekonomi | 27.11.2024. Nasıl Bir Ekonomi | 27.11.2024.

Dünya | 21.03.2024

Dünya | 21.03.2024. Dünya | 21.03.2024. Dünya | 21.03.2024.

In Business dergisi | 06.09.2024

In Business dergisi | 06.09.2024. In Business dergisi | 06.09.2024. In Business dergisi | 06.09.2024.

IN THE MEDIA



Polat Makina, Sektöre Nitelikli Üçü Sağlayacak

Polat Makina, Sektöre Nitelikli Üçü Sağlayacak. Polat Makina, Sektöre Nitelikli Üçü Sağlayacak. Polat Makina, Sektöre Nitelikli Üçü Sağlayacak.

Sektörel Tanıtım Makina | 01.05.2024

Sektörel Tanıtım Makina | 01.05.2024. Sektörel Tanıtım Makina | 01.05.2024. Sektörel Tanıtım Makina | 01.05.2024.

Nasıl Bir Ekonomi |

Polat Group Holding'den çevreci imza

Polat Group Holding'den çevreci imza. Polat Group Holding, Birleşmiş Milletler (BM) Küresel İlkeler Sözleşmesi'ne (UN Global Compact) imza attı. Polat Group Holding...

Aydın'dan Dünyaya Açılan Bir Sanayi Serüveni: Polat Group Holding

Aydın'dan Dünyaya Açılan Bir Sanayi Serüveni: Polat Group Holding. Polat Group Holding, Aydın'dan Dünyaya Açılan Bir Sanayi Serüveni: Polat Group Holding.

Polat Group Holding, TEİE'ye Üye Oldu

Polat Group Holding, TEİE'ye Üye Oldu. Polat Group Holding, TEİE'ye Üye Oldu. Polat Group Holding, TEİE'ye Üye Oldu.



Polat Makina, Sektöre Nitelikli Üçü Sağlayacak

Polat Makina, Sektöre Nitelikli Üçü Sağlayacak. Polat Makina, Sektöre Nitelikli Üçü Sağlayacak. Polat Makina, Sektöre Nitelikli Üçü Sağlayacak.

Sektörel Tanıtım Proses Otomasyonu | 01.10.2024

Sektörel Tanıtım Proses Otomasyonu | 01.10.2024. Sektörel Tanıtım Proses Otomasyonu | 01.10.2024. Sektörel Tanıtım Proses Otomasyonu | 01.10.2024.

Polat Makina SX 920 ile kendi rekorunu kırdı

Polat Makina SX 920 ile kendi rekorunu kırdı. Polat Makina, SX 920 ile kendi rekorunu kırdı. Polat Makina, SX 920 ile kendi rekorunu kırdı.

Polat Makina, Sektöre Nitelikli Üçü Sağlayacak

Polat Makina, Sektöre Nitelikli Üçü Sağlayacak. Polat Makina, Sektöre Nitelikli Üçü Sağlayacak. Polat Makina, Sektöre Nitelikli Üçü Sağlayacak.

Polat Makina Genel Müdürü L. Muttu Şahin: Modern teknolojiyi

Polat Makina Genel Müdürü L. Muttu Şahin: Modern teknolojiyi... Polat Makina Genel Müdürü L. Muttu Şahin: Modern teknolojiyi...



Polat Makina, Sektöre Nitelikli Üçü Sağlayacak

Polat Makina, Sektöre Nitelikli Üçü Sağlayacak. Polat Makina, Sektöre Nitelikli Üçü Sağlayacak. Polat Makina, Sektöre Nitelikli Üçü Sağlayacak.

Sektörel Tanıtım Proses Otomasyonu | 01.10.2024

Sektörel Tanıtım Proses Otomasyonu | 01.10.2024. Sektörel Tanıtım Proses Otomasyonu | 01.10.2024. Sektörel Tanıtım Proses Otomasyonu | 01.10.2024.

Polat Makina SX 920 ile kendi rekorunu kırdı

Polat Makina SX 920 ile kendi rekorunu kırdı. Polat Makina, SX 920 ile kendi rekorunu kırdı. Polat Makina, SX 920 ile kendi rekorunu kırdı.

Polat Makina, Sektöre Nitelikli Üçü Sağlayacak

Polat Makina, Sektöre Nitelikli Üçü Sağlayacak. Polat Makina, Sektöre Nitelikli Üçü Sağlayacak. Polat Makina, Sektöre Nitelikli Üçü Sağlayacak.

Polat Makina Genel Müdürü L. Muttu Şahin: Modern teknolojiyi

Polat Makina Genel Müdürü L. Muttu Şahin: Modern teknolojiyi... Polat Makina Genel Müdürü L. Muttu Şahin: Modern teknolojiyi...



Polat Makina, Sektöre Nitelikli Üçü Sağlayacak

Polat Makina, Sektöre Nitelikli Üçü Sağlayacak. Polat Makina, Sektöre Nitelikli Üçü Sağlayacak. Polat Makina, Sektöre Nitelikli Üçü Sağlayacak.

Sektörel Tanıtım Proses Otomasyonu | 01.10.2024

Sektörel Tanıtım Proses Otomasyonu | 01.10.2024. Sektörel Tanıtım Proses Otomasyonu | 01.10.2024. Sektörel Tanıtım Proses Otomasyonu | 01.10.2024.

Polat Makina SX 920 ile kendi rekorunu kırdı

Polat Makina SX 920 ile kendi rekorunu kırdı. Polat Makina, SX 920 ile kendi rekorunu kırdı. Polat Makina, SX 920 ile kendi rekorunu kırdı.

Polat Makina, Sektöre Nitelikli Üçü Sağlayacak

Polat Makina, Sektöre Nitelikli Üçü Sağlayacak. Polat Makina, Sektöre Nitelikli Üçü Sağlayacak. Polat Makina, Sektöre Nitelikli Üçü Sağlayacak.

Polat Makina Genel Müdürü L. Muttu Şahin: Modern teknolojiyi

Polat Makina Genel Müdürü L. Muttu Şahin: Modern teknolojiyi... Polat Makina Genel Müdürü L. Muttu Şahin: Modern teknolojiyi...



Polat Makina, Sektöre Nitelikli Üçü Sağlayacak

Polat Makina, Sektöre Nitelikli Üçü Sağlayacak. Polat Makina, Sektöre Nitelikli Üçü Sağlayacak. Polat Makina, Sektöre Nitelikli Üçü Sağlayacak.

Sektörel Tanıtım Proses Otomasyonu | 01.10.2024

Sektörel Tanıtım Proses Otomasyonu | 01.10.2024. Sektörel Tanıtım Proses Otomasyonu | 01.10.2024. Sektörel Tanıtım Proses Otomasyonu | 01.10.2024.

Polat Makina SX 920 ile kendi rekorunu kırdı

Polat Makina SX 920 ile kendi rekorunu kırdı. Polat Makina, SX 920 ile kendi rekorunu kırdı. Polat Makina, SX 920 ile kendi rekorunu kırdı.

Polat Makina, Sektöre Nitelikli Üçü Sağlayacak

Polat Makina, Sektöre Nitelikli Üçü Sağlayacak. Polat Makina, Sektöre Nitelikli Üçü Sağlayacak. Polat Makina, Sektöre Nitelikli Üçü Sağlayacak.

Polat Makina Genel Müdürü L. Muttu Şahin: Modern teknolojiyi

Polat Makina Genel Müdürü L. Muttu Şahin: Modern teknolojiyi... Polat Makina Genel Müdürü L. Muttu Şahin: Modern teknolojiyi...

Vitamins for Cute Friends from PG Kimya

In this issue of Polat Life, we are here with the product of VetnaCare, one of the brands of PG Kimya, one of our subsidiaries, which supports the development of cats and dogs and helps protect their health: VetNaVit MultiPlus, a mixture of vitamins, minerals and amino acids that support the development of cats and dogs. With VetNaVit MultiPlus, you can safely use feed additives that support the hair structure, digestive system, immune system and other organ functions of our lovely friends in all age groups.

Like every living creature, our beloved friends need a variety of nutrients to live a healthy life. Chief among these are vitamins, which are organic compounds essential for the normal functioning of the body.

Vitamins need to be taken from outside as they cannot be produced in the body on their own. Vitamin deficiency can lead to a variety of health problems in dogs and cats, as in all living things. These problems include slowed growth and development, weakened immune system, skin and coat problems, digestive system problems, bone and joint problems. To prevent these, we can use VetNaVit MultiPlus, a vitamin, mineral and amino acid supplement special developed for cats and dogs. VetNaVit MultiPlus can also be used to protect against and prevent possible diseases that may occur during seasonal transitions.

VetNaVit MultiPlus is a vitamin supplement that supports the hair structure, digestive system, immune system and other organ functions of cats and dogs of all age groups.

VetNaVit MultiPlus can also be considered as a vitamin and mineral complex thanks to its rich content.

The functions of the vitamins in VetNaVit MultiPlus are as follows:

Vitamin E: It is a very powerful antioxidant. strengthens immune function and protects the body against infectious diseases.

Vitamin A: Essential for vision, growth, reproduction, blood production, immune system and tissue growth.

Vitamin D3: Plays an important role in the absorption of calcium and phosphorus, which maintain bone health and strengthen bone structure.

Vitamin B1: Protects cardiovascular health, supports intestinal and digestive health, and supports eye health.

Vitamin B6: Supports nervous system health, strengthens immune functions and contributes to the production of red blood cells.

Folic Acid: It is effective in the renewal of cells in the body and the formation of new cells.

AND US

S

S

S

S

S

S



VetNaVit MultiPlus can be given as a daily 5 g MultiPlus supplement for every 10 kg of our pet's body weight.

It is important that our cats and dogs take vitamin supplements regularly. The effect of vitamin supplements is more noticeable with regular use.

As a result, multivitamin supplements are an important support for our cute friends to lead a healthy life.



Small in Size, Big in Love and Expertise

VetNaVit MULTIPLUS

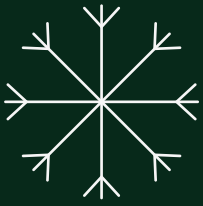
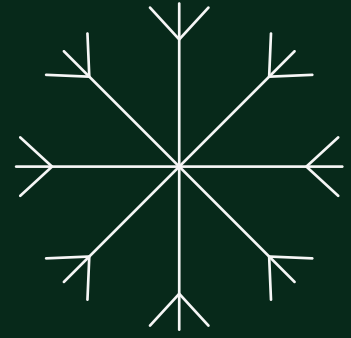

POUAT *life*

