

MAINTENANCE AND OPERATION INSTRUCTIONS | EN

PL / PLB SERIES

Planet Geared

GEAR UNIT WITH MOTORS / WITHOUT MOTORS

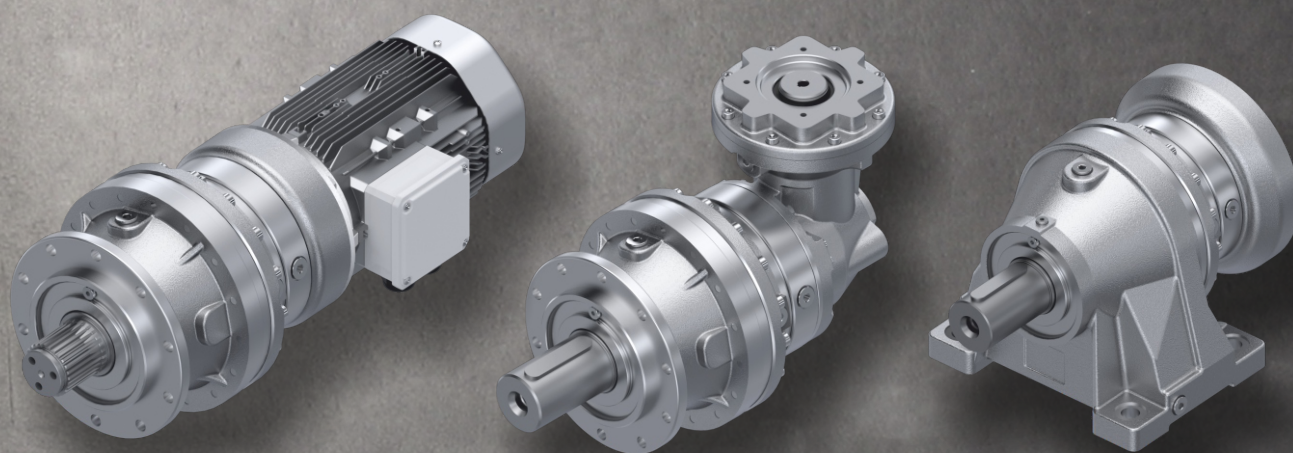

PGR[®]
DRIVE TECHNOLOGIES

Doc. No: PG.AG.KK.001_01

Rev. / Publication Date: 01.2021 / 04.2019

TSE K 558



Certificate No: KY3723/05/10-R15





The copyrights of the usage Maintenance instruction are belong to PGR company.

Usage guide could not be used partially or fully without our permission to the purpose of competition and not submitted to the use of third parties.

The right of changing informations which stated in the usage maintenance instruction partially or fully without giving any notice before or right of full changing and abolishment are kept reserved by us.



1. UNIT



GENERAL INFORMATION

1.1	Important Warnings	5
1.2	General Information	6
1.3	Correct Use	6
1.4	Safety Information	6
1.5	Responsibility	7
1.6	Transportation	7 - 20
1.6.1	Transportation and Freightage	7
1.6.2	Package Transportation	7
1.6.3	Equipment Transportation	8
1.6.4	Transport of Gearboxes	9 - 20
1.7	Storage	21
1.7.1	Long Term Storage Suggestions	21

2. UNIT



PRODUCT DESCRIPTION

2.1	Gear Unit Label	22
2.2	Explanations	23 - 24
2.3	Abbreviations	25

3. UNIT



ASSEMBLY INSTRUCTIONS; PREPARATION, INSTALLATION

3.1	Prerequisites of Assembly	26
3.2	Gear Unit Mounting	27
3.2.1	Bolt Tightening Torque Value	28
3.3	Gear Unit Ventilation	28
3.4	Retrospective Paintwork	29
3.5	The Mountage of the Connection Tool to the Output Shaft	29
3.6	The Mountage of the Couplings	29
3.7	The Mountage of the Standard B5 Motor to the PAM Gear Unit	30
3.8	The Demountage of the Electrical Motor (PAM)	30
3.9	Gear Unit Operating	30

4. UNIT



CONTROL AND MAINTENANCE

4.1	Control and Periodic Maintenance	31
4.2	Visual Inspection	32
4.3	Check for Running Noises	32
4.4	Control of the Lubricant and Lubricant Level	32
4.5	Changing the Oil	32 - 33
4.6	Oil Plugs Squeezing Torc Chart	33
4.7	Change of the Ventilation Plug	33
4.8	Change of the Oil Seal and Oil Cover	33
4.9	The Bearing Greases	34
4.10	General Overhaul	34
4.11	The Maintenance of the Motor	34



5. UNIT		MOUNTING POSITIONS	
5.1		Mounting Positions	35 - 39
6. UNIT		LUBRICATION	
6.1		Lubrication	40
6.2		Lubrication Table	40
7. UNIT		ACCESSORIES	
7.1		Expansion Tank	41
7.2		Shrink Disc	42
7.2.1		Mounting Position of the Shrink Disc	42
7.2.2		Demounting Position of the Shrink Disc	43
7.2.3		Cleaning of the Shrink Disc	43
7.3		Torque Arm	43
7.4		Backstop	44
7.5		Input Accessories	44
8. UNIT		THE ELECTRICAL MOTOR AND BRAKE CONNECTION	
8.1		The Electrical Motor and Brake Connection	45
8.2		The Electrical Motor Connection Schema	46
8.3		Standard Type Brake Anchorage Schema	47
9. UNIT		TROUBLESHOOTING	
9.1		Product Disposal	48
9.1.1		Disposal	48
9.2		Troubleshooting	49 - 52
10. UNIT		AUTHORIZED SERVICE	
10.1		Authorized Service	53
11. UNIT		CONTACT INFORMATION	
11.1		Contact Information	54



List of illustrations

Figure 1 : Transport of Gearboxes	9 - 20
Figure 2 : Gearbox Nameplate and Explanation	22
Figure 3 : Activation of Vent Plug	28
Figure 4 : The Mountage of the Connection Tool to the Output Shaft	29
Figure 5 : The Mountage of the Coupling	29
Figure 6 : The Demountage of the Electrical Motor (PAM)	30
Figure 7 : Mounting Positions	35 - 39
Figure 8 : Expansion Tank	41
Figure 9 : Shrink Disc	42
Figure 10 : Torque Arm	43
Figure 11 : Input Accessories	44
Figure 12 : The Electrical Motor Connection Schema	46
Figure 13 : Standard Type Brake Anchorage Schema	47

**List of tables**

Table 1 : Safety Alerts and Information Signs	5
Table 2 : Product Description (Explanations)	23
Table 3 : Product Description (Accessories)	24
Table 4 : Abbreviations	25
Table 5 : Bolt Tightening Moments	28
Table 6 : Control and Periodic Maintenance Ranges - Works	31
Table 7 : Oil Plugs Squeezing Torc Chart	33
Table 8 : Lubrication Table	40
Table 9 : Lubrication Schedule While Cleaning of Shrink Disc	43
Table 10: Disposal Table	48
Table 11: Troubleshooting	49 - 52
Table 12: Authorized Service	53

1.1 Important Warnings

Take into consideration the listed safety warnings and information signs below!

Table 1: Safety Alerts and Information Signs

	ATTENTION ! Dangerous position and possible result Slight and unimportant woundings
	NOTE ! Advices and necessary informations for the user
	DANGER ! Harmful position and possible result Damage in gear unit and environment
	DANGER OF ELECTRICITY ! Danger of electrical shock and possible result Death and heavy woundings
	DANGER ! Danger possible result Death and heavy woundings

1.2 General Information

This user guide is prepared by our firm to provide information about safety transportation of gear unit/gear unit with motors, storage, installation/mounting, connection, operating, maintenance and repair processes. All the purchase and technical data are positioned at product catalogues. Beside engineering applications, the information which is placed in this instruction, should be well read and applied. The documents must be protected and to get ready for controlling by authorized person. The information about electrical motor could be found by guidance which is prepared by motor-producing firm.

1.3 Correct Use

PGR The products are designed to use in commercial plants and are operated convenient to the current standards and directions. Technical data and allowed usage conditions are placed in product's power tab and usage guidance. Should be conformed to all the values.

This usage guidance is prepared by our firm according to 2006/42/EC The European Union Machinery Safety Instructions and is not be in placed 2014/34/EU "The direction about tools used in possible explosive environment and protective systems".

1.4 Safety Information

In gear units /gear units with motors and motors, there could be pieces subjected to voltage, movable pieces and hot areas. During all the works to be done; transportation, storage, placing, mounting, connection, operating, maintenance-repair processes could be implemented by qualified employees and responsible managers.

All the processes to be implemented during the working period;

- Related usage and maintenance instructions,
- Warning and Safety Tags in gear unit/gear unit with motor,
- Instructions and Requirements related to the system,
- Local and International requirements for safety and accidental protection.

Our Firm is not responsible where the listed items are implemented below:

- Violation of work health and safety rules in gear unit /gear unit with motors,
- Improper usage (The usage which stated out of bounds in guidance and all the usages except tag/catalogue values especially usage in high moment and different cycle) and mismounting and misuse of gear unit/gear unit with motor in plant,
- Extremely dirty and maintenance free of gear unit/gear unit with motor,
- Unlubricated usage,
- Usage of product other than out of tag/catalogue values,
- Wrong motor selection,
- Take out of the necessary protective plugs,
- Disuse of original pieces in gear unit/gear unit with motor,
- The using, mounting, maintaining and taking place of the uneducated, unauthorized and unqualified 3. persons.

1.5 Responsibility

PGR, declines any responsibility in case of:

- Use of the reducer not compliant with national laws on safety and accident prevention,
- Work done by unqualified personnel,
- Incorrect installation,
- Tampering with the product,
- Incorrect or failure to follow the instructions in the manual,
- Incorrect or failure to follow the indications marked on the identification labels fixed on the units,
- For motor gearboxes, wrong delivery of electrical power,
- Incorrect connections and/or use of temperature sensors (when present),
- Use of gearbox under unlubricated conditions,
- The contents of this manual were reviewed to ensure consistency with the catalogues and etc. documents. We cannot guarantee full consistency since the changes cannot be completely prevented. However, the informations in this manual are reviewed regularly and necessary revisions are made in next editions.

The products supplied by PGR are intended to be incorporated into "complete machines", so it is prohibited to put them into service until the entire machine has not been declared compliant.

	<p>ATTENTION !</p> <p>The configurations provided in the catalogue of the unit are the only ones allowed. Do not use the product in contrast with the indications provided in it. The instructions provided in this manual do not replace but compensate the obligations of current laws concerning safety regulations.</p>
--	--

1.6 Transportation

1.6.1 Transportation and Freightage;

- Take into consideration of the article stated on package during the product delivery.
- During the delivery, product should be controlled about possible damages in carrying period.
- The firm should be informed about possible damages.
- The damaged products should not be put into use.
- Lifting flanged eyebolts must be tightened. These flanged eyebolts sized to carry the weight of only gear unit/ gear unit with motor. The additional weight should not be added. The flanged eyebolts must be suitable to the DIN 580 norm.
- If there are 2 lifting flanged eyebolts in gear unit with motor, both of them could be used in carrying process upon the size of gear unit and motor. In necessary situations, the suitable and adequated-size carrier should be used.
- Carrying safeties should be removed before the start of operating.
- The weights of the movable gear units/gear units with motors are placed in product catalogues.
- The dangerous area should be got into the secure to prevent damage to the persons.
- During the carrying process, to stand under the gear unit could cause danger of death.
- The damage of gear unit must be prevented. The crushes to the free input shafts could damaged into the gear unit.

1.6.2 Package Transportation;

- There could be no loads on packages or the shelved surfaces should be prepared.
- The necessary carrying equipments should be prepared.
- The carrying and lifting equipments should be larged - enough to the sufficient capacity.
- The calculations should be made to the connection points and center of gravity.
- If necessary, this information should be written on the package.
- The carrying equipments (steel rope, belt, chain etc.) must be robust and suitable to the applied weight.
- During the carrying process, the load centering could be done without oscillation.

1.6.3 Equipment Transportation;

- The connection carrying point should be appointed.
- The carrying equipments (hook, chain, belt) must be prepared. To the alternative, pallet must be used for the load - lifting.
- If the Crane will be used, it could be lifted perpendicular from inside to the outside of the package.
- If the forklift or palletized carrying equipment will be used, the product which removed from package should be placed on the pallet.
- The fork of the equipment should be carried out the way that gripped the pallet.
- The weight must be lifted both with slowly and constant speed and must take measure to the sudden oscillation.



ATTENTION !

During the carrying process, the fixings like the lifting lug, hook, belt, rope, locked hook must be sufficient to the load and have conformity certificate. The weights of the movable gear unit/gear unit with motor have given in product catalogue.



NOTE !

In all carrying processes, there should be avoided from both sudden movements and sudden liftings.



ATTENTION !

If the connection tool is coupling between electric motor and gear unit, lifting eyebolt should not be used.

1.6.4 Transport of Gearboxes;

Figure 1: Transport of Gearboxes

PL - MS

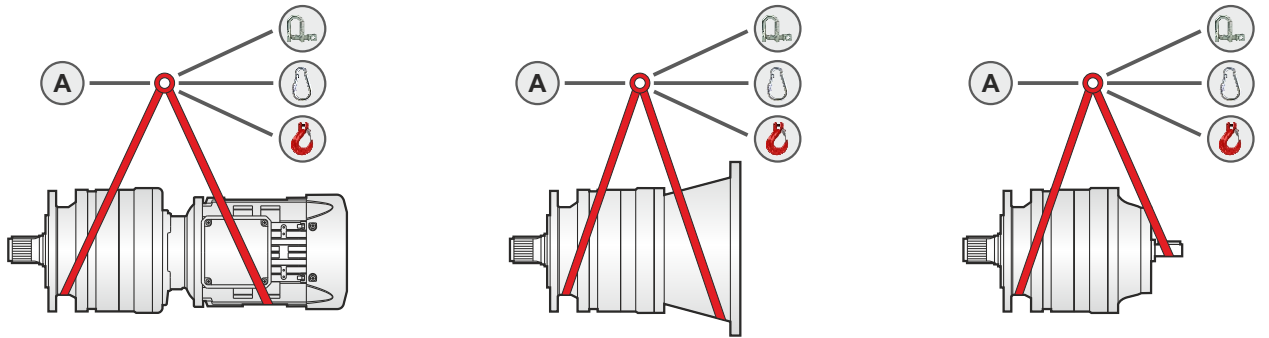

PL - MC

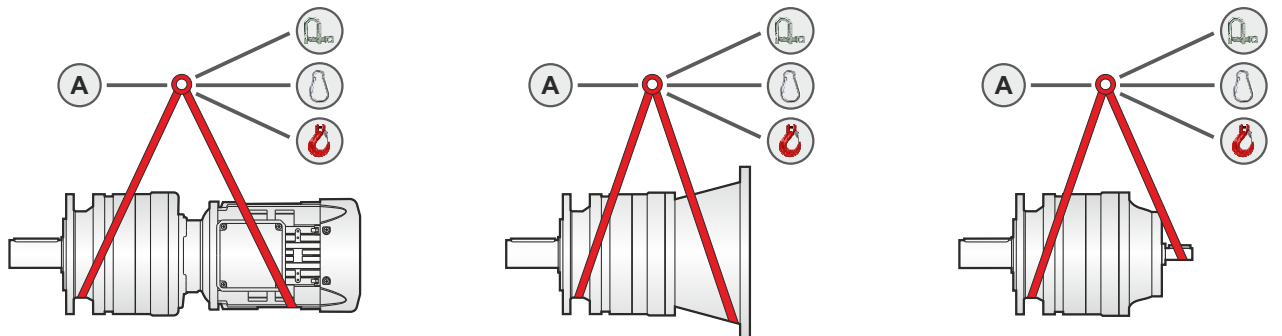

A Hoop equipped (swab)

Load hook

Screw hook

Locked hook

Manual lifting (Weight ≤ 15 kg)
(ref. ILO Contract)
Not valid for the continuous carrying.



The allowable maximum slope is 15 degree.

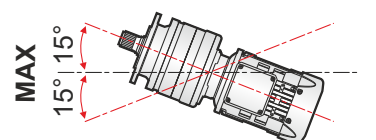

PL - PS

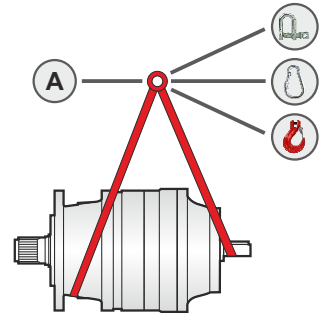
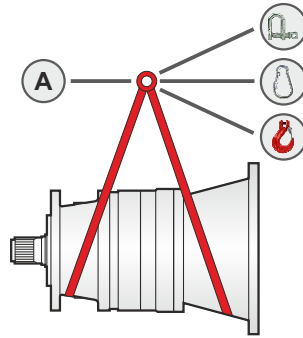
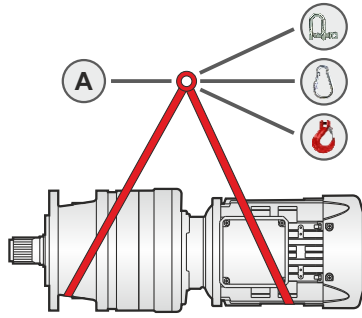

PL - PC

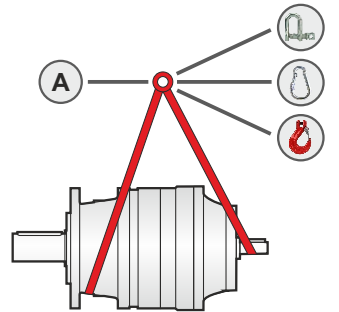
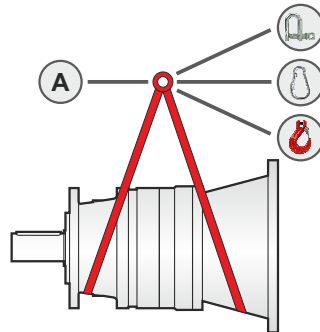
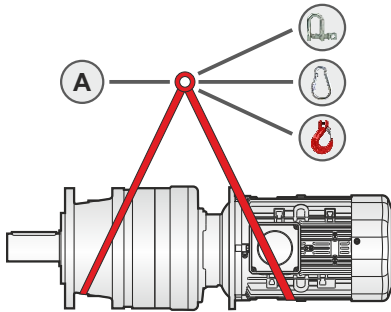

A Hoop equipped (swab)

Load hook

Screw hook

Locked hook

Manual lifting (Weight ≤ 15 kg)
(ref. ILO Contract)
Not valid for the continuous carrying.



The allowable maximum slope is 15 degree.

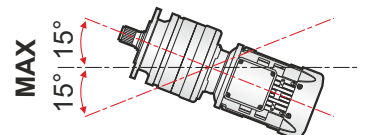

PL - FS

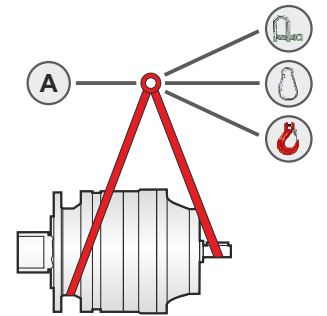
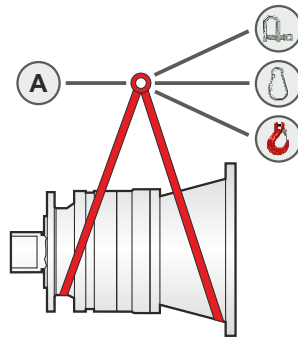
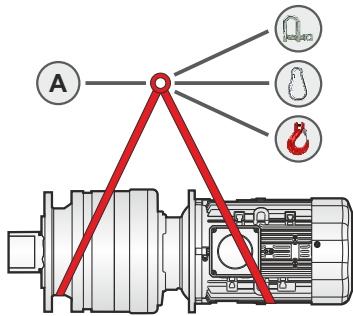

PL - F

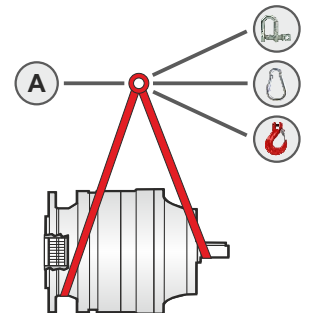
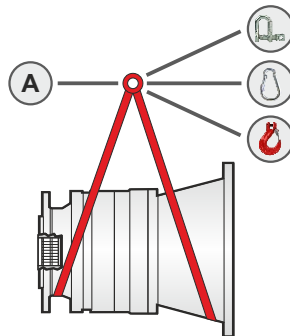
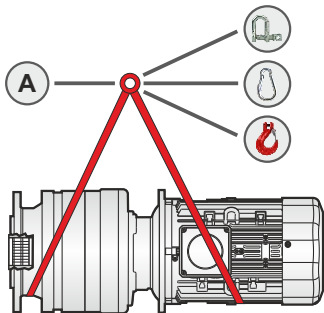

A Hoop equipped (swab)

Load hook

Screw hook

Locked hook

Manual lifting (Weight ≤ 15 kg)
(ref. ILO Contract)
Not valid for the continuous carrying.



The allowable maximum slope is 15 degree.

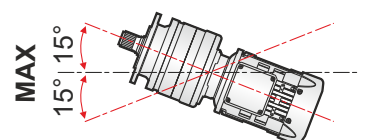

PL - CPC

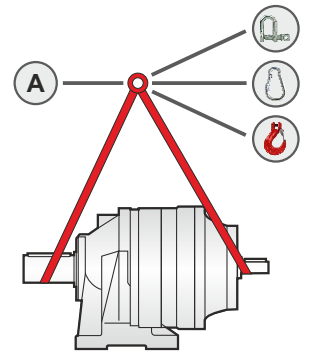
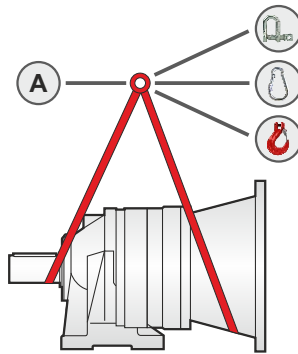
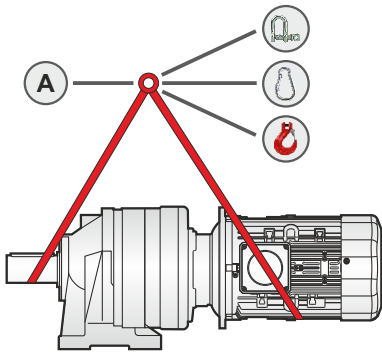

A Hoop equipped (swab)

Load hook

Screw hook

Locked hook

Manuel lifting (Weight ≤ 15 kg)
(ref. ILO Contract)
Not valid for the continuous carrying.



The allowable maximum slope is 15 degree.

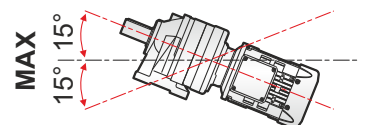



PL - MS

PMRV / PRV

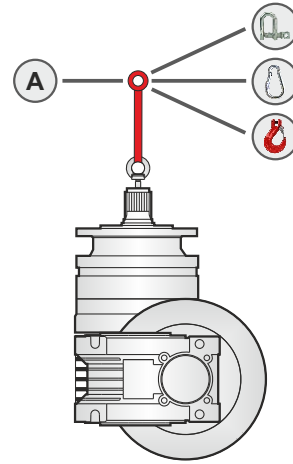
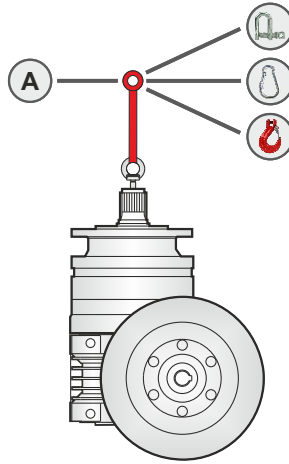

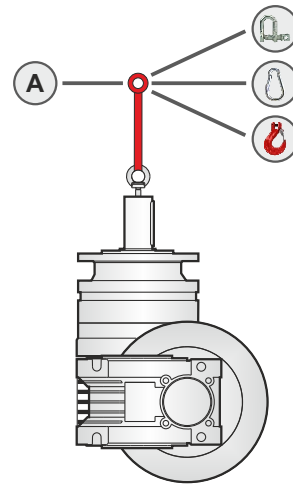
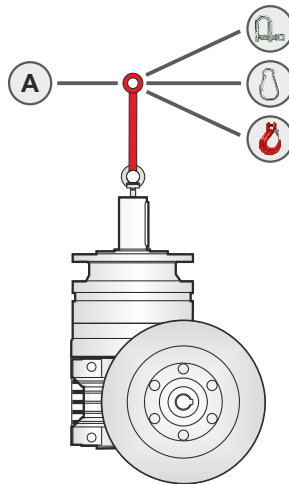

PL - MC

PMRV / PRV



A Hoop equipped (swab)

 Load hook

 Screw hook

 Locked hook

Manual lifting (Weight ≤ 15 kg)
(ref. ILO Contract)
Not valid for the continuous carrying.



The allowable maximum slope is 15 degree.

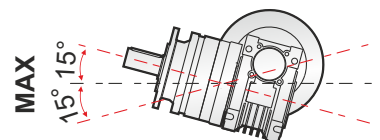

PL - PS

PMRV / PRV

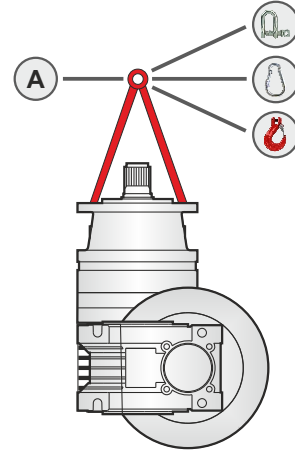
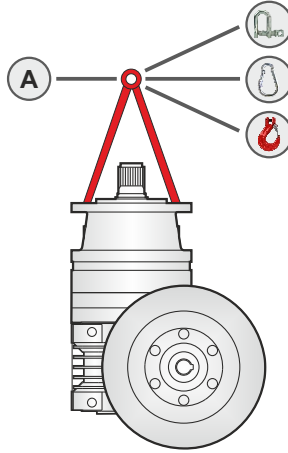

PL - PC

PMRV / PRV

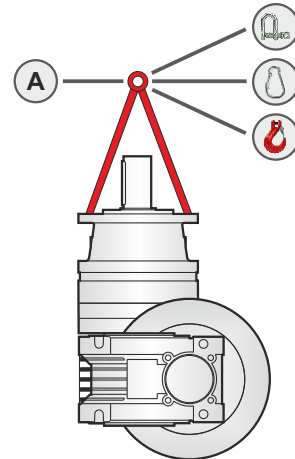
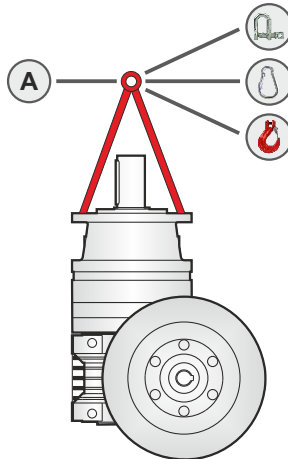

A Hoop equipped (swab)

Load hook

Screw hook

Locked hook

Manual lifting (Weight ≤ 15 kg)
(ref. ILO Contract)
Not valid for the continuous carrying.



The allowable maximum slope is 15 degree.

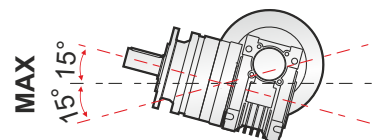

PL - FS

PMRV / PRV

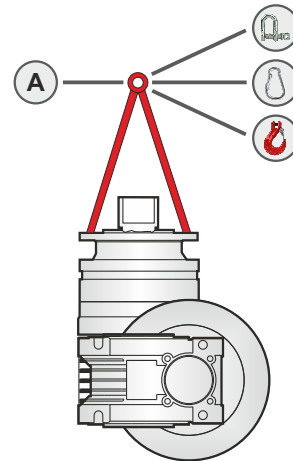
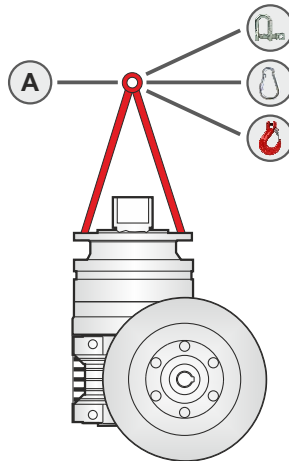

PL - F

PMRV / PRV

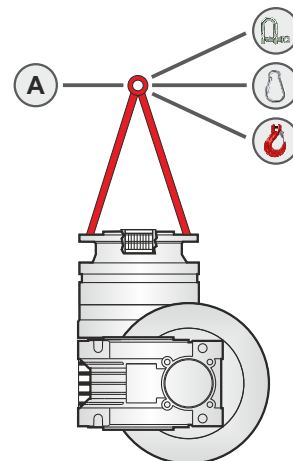
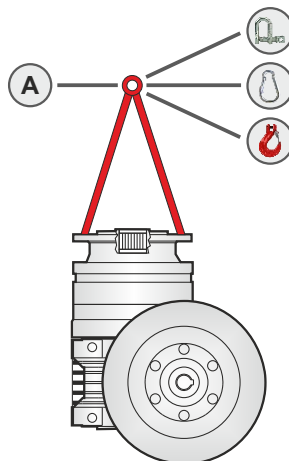

A Hoop equipped (swab)

Load hook

Screw hook

Locked hook

Manual lifting (Weight ≤ 15 kg)
(ref. ILO Contract)
Not valid for the continuous carrying.



The allowable maximum slope is 15 degree.

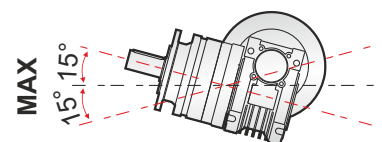

PL - CPC

PMRV / PRV

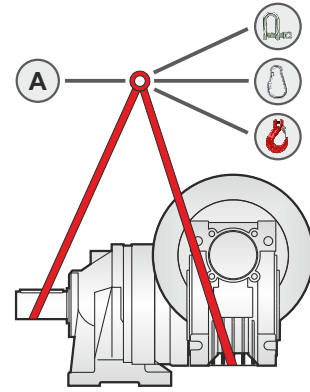
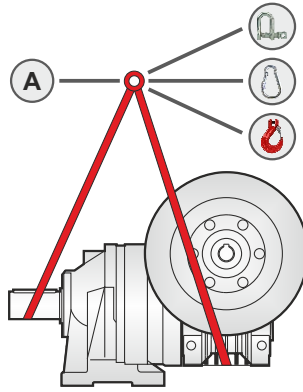

A Hoop equipped (swab)

Load hook

Screw hook

Locked hook

Manuel lifting (Weight ≤ 15 kg)
(ref. ILO Contract)
Not valid for the continuous carrying.



The allowable maximum slope is 15 degree.

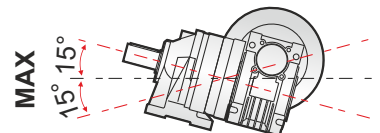

PLB - MS

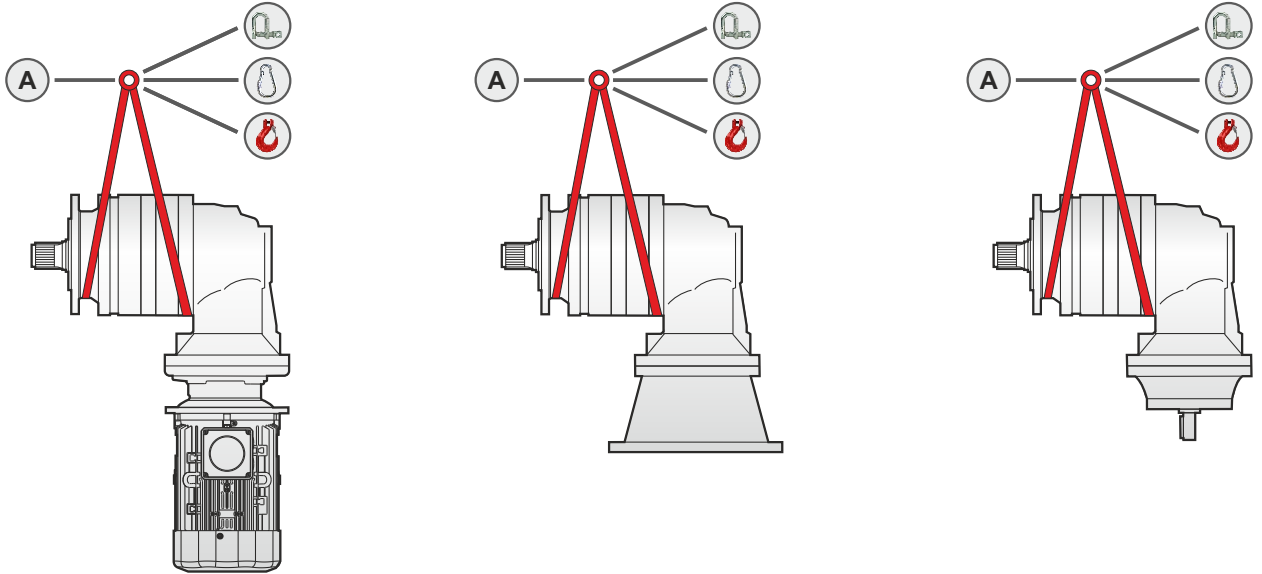

PLB - MC

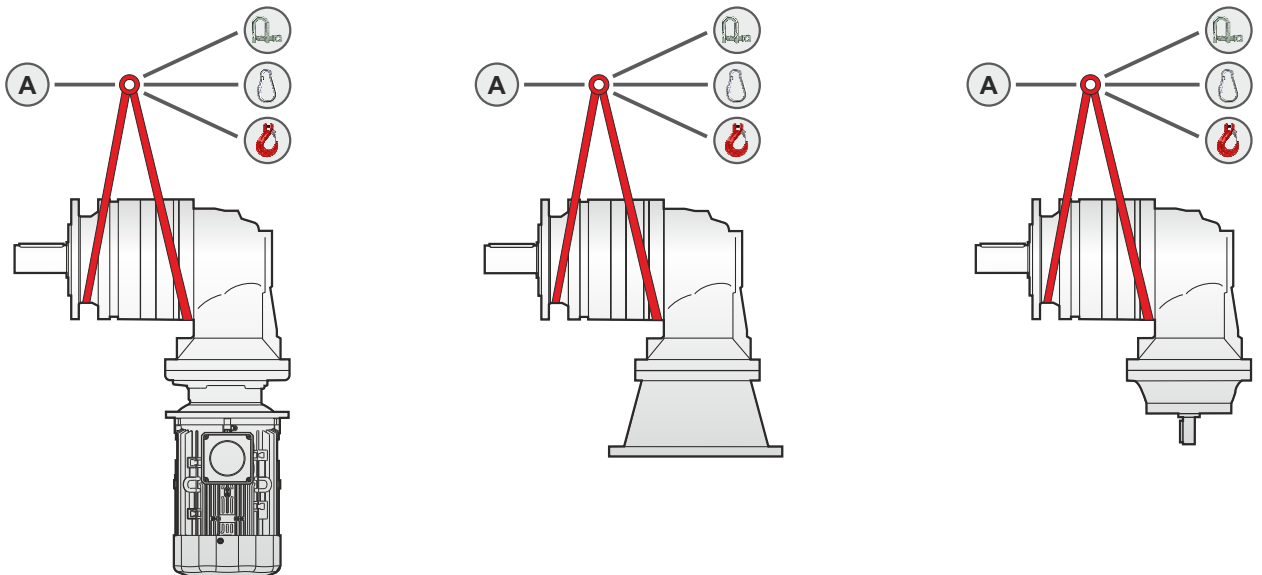

A Hoop equipped (swab)

Load hook

Screw hook

Locked hook

Manual lifting (Weight ≤ 15 kg)
(ref. ILO Contract)
Not valid for the continuous carrying.



The allowable maximum slope is 15 degree.

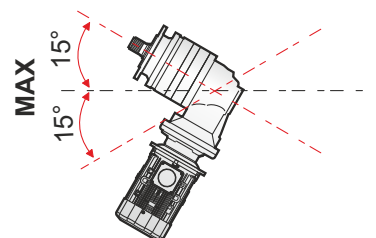

PLB - PS

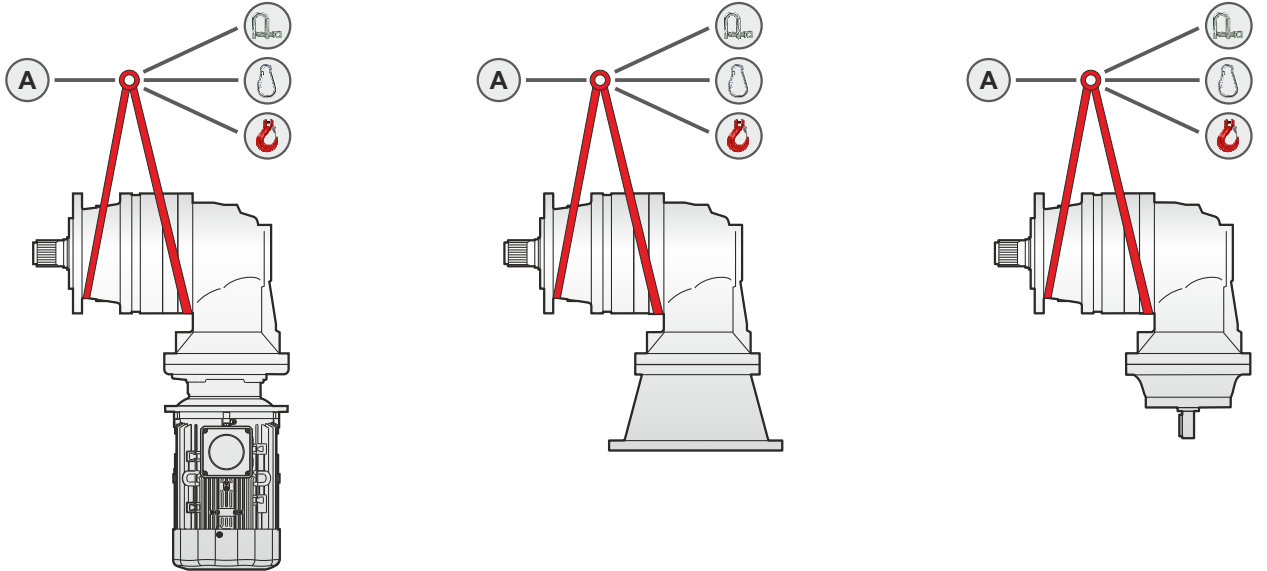

PLB - PC

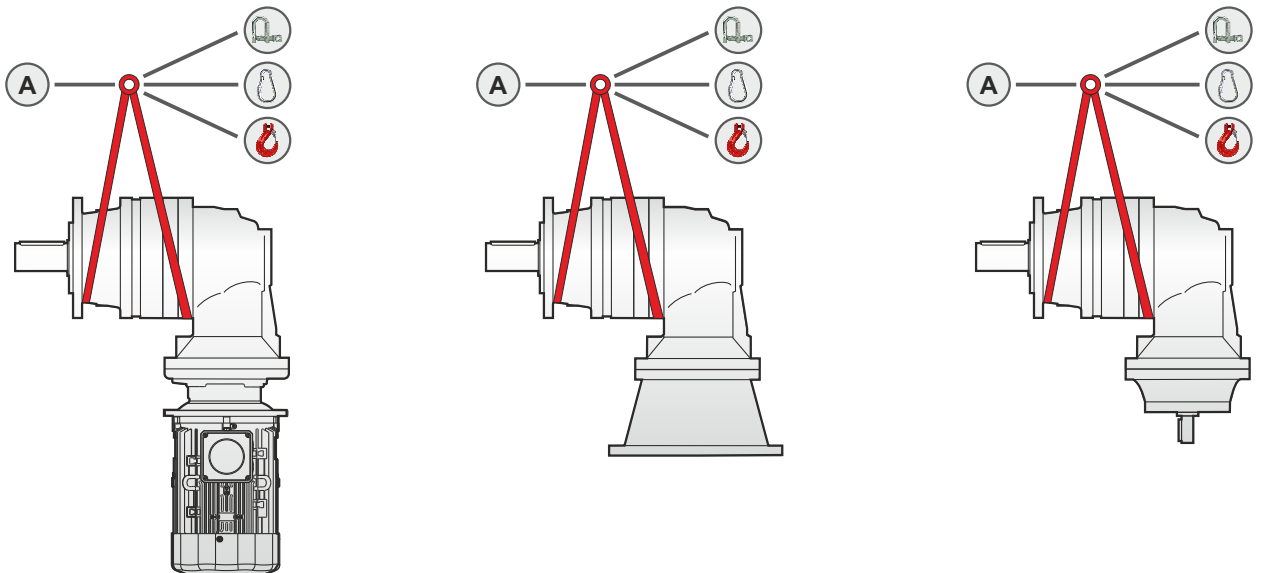

- A** Hoop equipped (swab)
- Load hook
- Screw hook
- Locked hook

Manuel lifting (Weight ≤ 15 kg)
(ref. ILO Contract)
Not valid for the continuous carrying.



The allowable maximum slope is 15 degree.

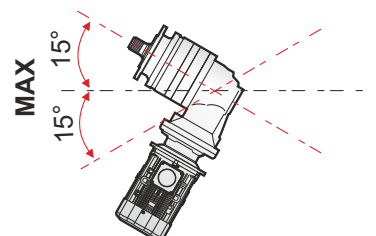

PLB - FS

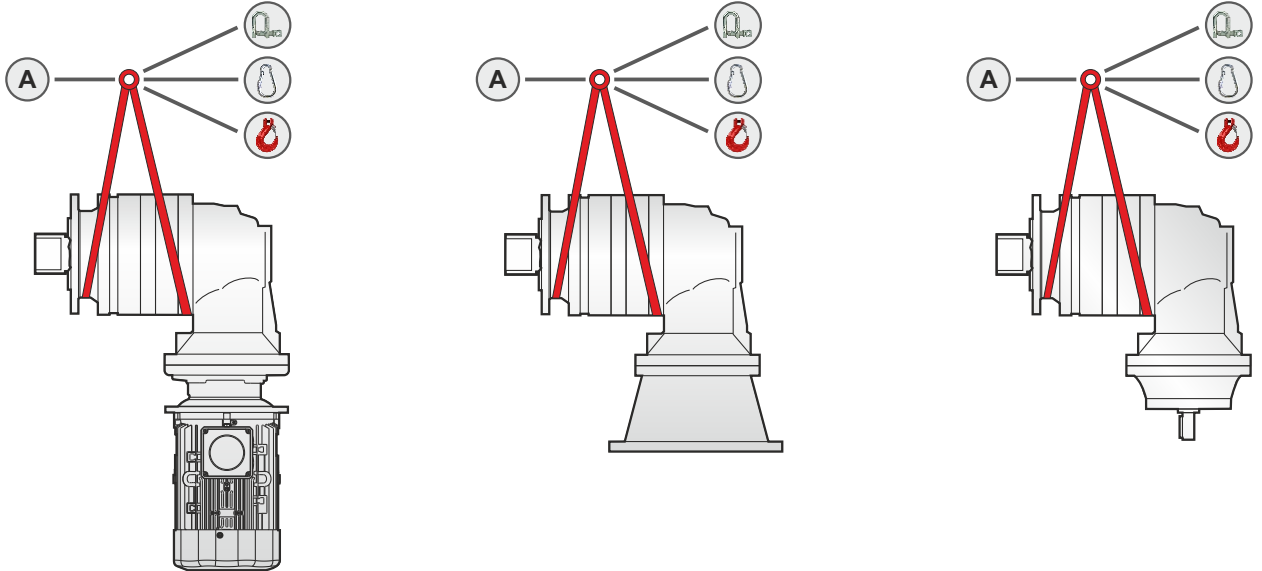

PLB - F

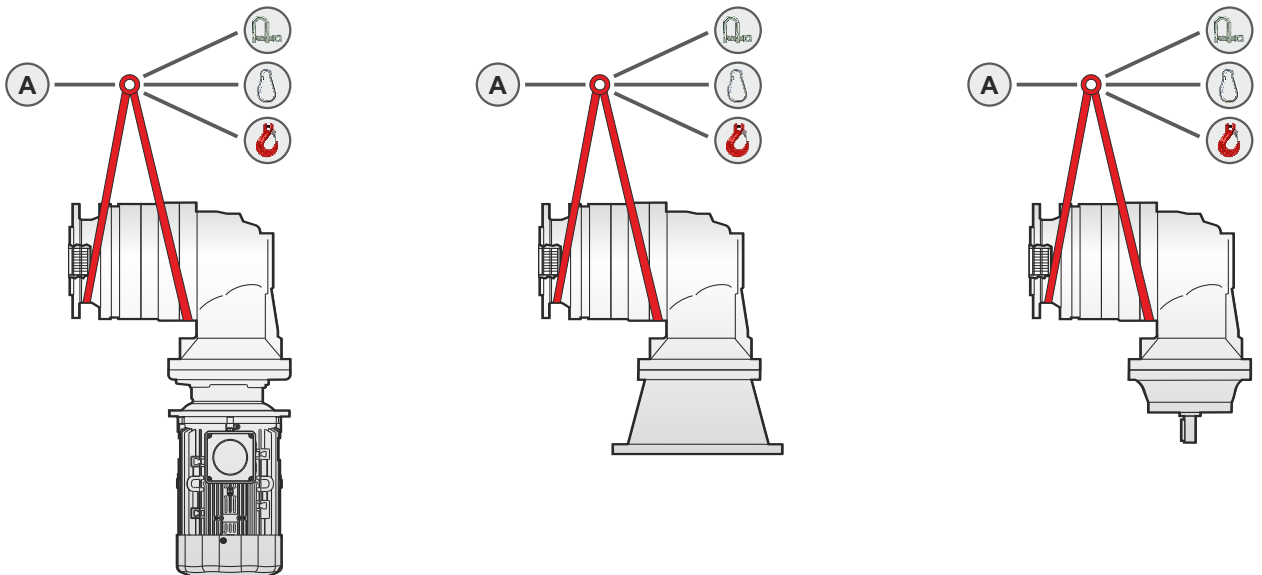

A Hoop equipped (swab)

Load hook

Screw hook

Locked hook

Manual lifting (Weight ≤ 15 kg)
(ref. ILO Contract)
Not valid for the continuous carrying.



The allowable maximum slope is 15 degree.

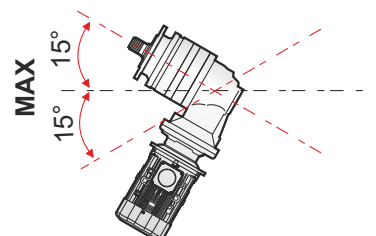

PLB - CPC

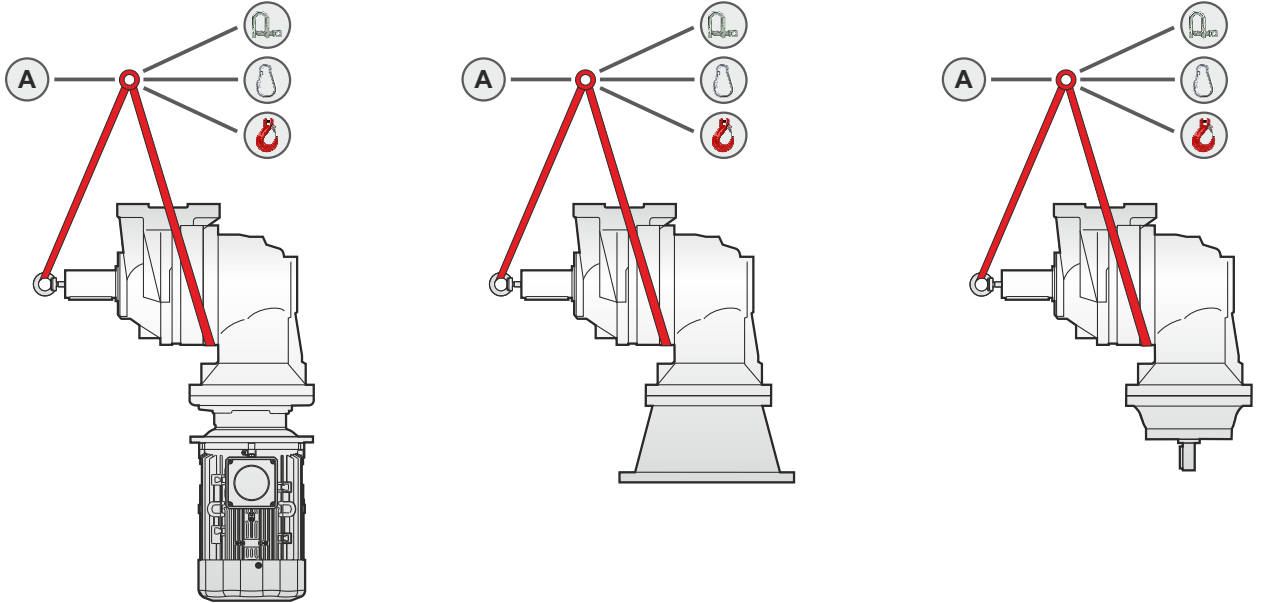

A Hoop equipped (swab)

Load hook

Screw hook

Locked hook

Manuel lifting (Weight ≤ 15 kg)
(ref. ILO Contract)
Not valid for the continuous carrying.



The allowable maximum slope is 15 degree.

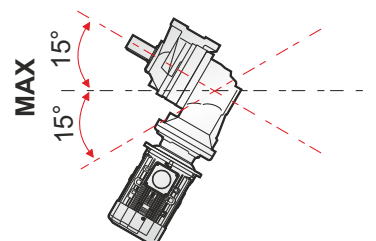



1.7 Storage

The certain suggestions have given about the storage conditions of the gear unit/gear unit with motor below;

- In clear and moist-airs, the storage should not be made.
- The gear unit/gear units with motor should not directly be contacted to the ground.
- The place must be moveless where the both gear unit/gear units with motors are contacted. Otherwise there could be damage during the movement.
- The gear unit should be got into the secure to the falling.
- The processed surfaces of the gear units and both solid and hollow shafts must be lubricated with protective oil.
- Gear unit/Gear units with motors must be in the place where there will be no big temperature differences between 0°C and +40°C.
- Relative humidity must be less than %60.
- Not directly be exposed to sunlight and infrared light.
- Must be kept away from the abrasive materials which causes corrosion (dirty weather, ozon, gases, solvents, acids, salts, radioactivity, etc.) in environment.
- The protective oil SHELL ENSIS or similar product should be used on the corrodible pieces.
- If the gear unit is without oil, it must be filled with lubrication oil.

1.7.1 Long Term Storage Suggestions;

	<p>NOTE !</p> <ul style="list-style-type: none"> - In the long-term storage or during the short-term storage, if the excessive temperature differences occur, the oil in the gear unit must be changed before the operating. - In the fully oil filled gear unit, the oil level should be reduced according to the mounting position.
	<p>ATTENTION !</p> <ul style="list-style-type: none"> - The incorrect and excessive long storage could cause the gearbox getting defected. - Please control not to exceed allowed storage period before starting up the gearbox.
	<p>NOTE !</p> <ul style="list-style-type: none"> - PGR, recommends long-term storage option for periods of more than 9 months holding and pausing times. - By paying attention both to the long-term storage option and precautions which listed below, the holding of goods up to 2 years could be possible. Because of real efficiency of gearboxes depending on local conditions widely, these periods could be seen solely guide values.

Long term storage suggestions;

- Mineral oil or synthetic oil according to mounting position is filled of getting available for operating. Despite this, the oil level should be controlled before operating.
- The VCI Corrosion protected tool are mixed into the gear unit's oil.
- The carrying safety of the ventilation plug must not be removed during the storage.
- The gear unit must be closed to the shape of unsealed.
- In case of storing axial piston or orbit type hydraulic motorized gearboxes, the motors would be filled with lubricant in order to prevent oxidation. (ISO VG 150 type). With the help of metal plugs and flanges, motor entrance and discharge hole are shut down.



2.1 Gear Unit Label

Important technical informations are found on gearbox's label.

Figure 2: Gearbox Nameplate and Explanation

PGR [®] DRIVE TECHNOLOGIES		Tel : 0256 231 19 12 - 16 (pbx) Fax: 0256 231 19 17 www.pgr.com.tr	
Type: ①			②
Serial No: ③			
M ₂ : ④	Nm	i: ⑤	
P ₁ : ⑥	kW	n ₂ : ⑦	min ⁻¹
f _B : ⑧		⚖️ ⑨	kg
🛢️ ⑩			📖 i
TSE K 558			



- ① Type
- ② Mounting position
- ③ Serial number
- ④ Output torque (Nm)
- ⑤ Reduction ratio
- ⑥ Rated power of motor [kW]
- ⑦ Output speed [d/dk]
- ⑧ Service factor
- ⑨ Weight of the geared motor (kg)
- ⑩ Used oil kind and amount (Lt)

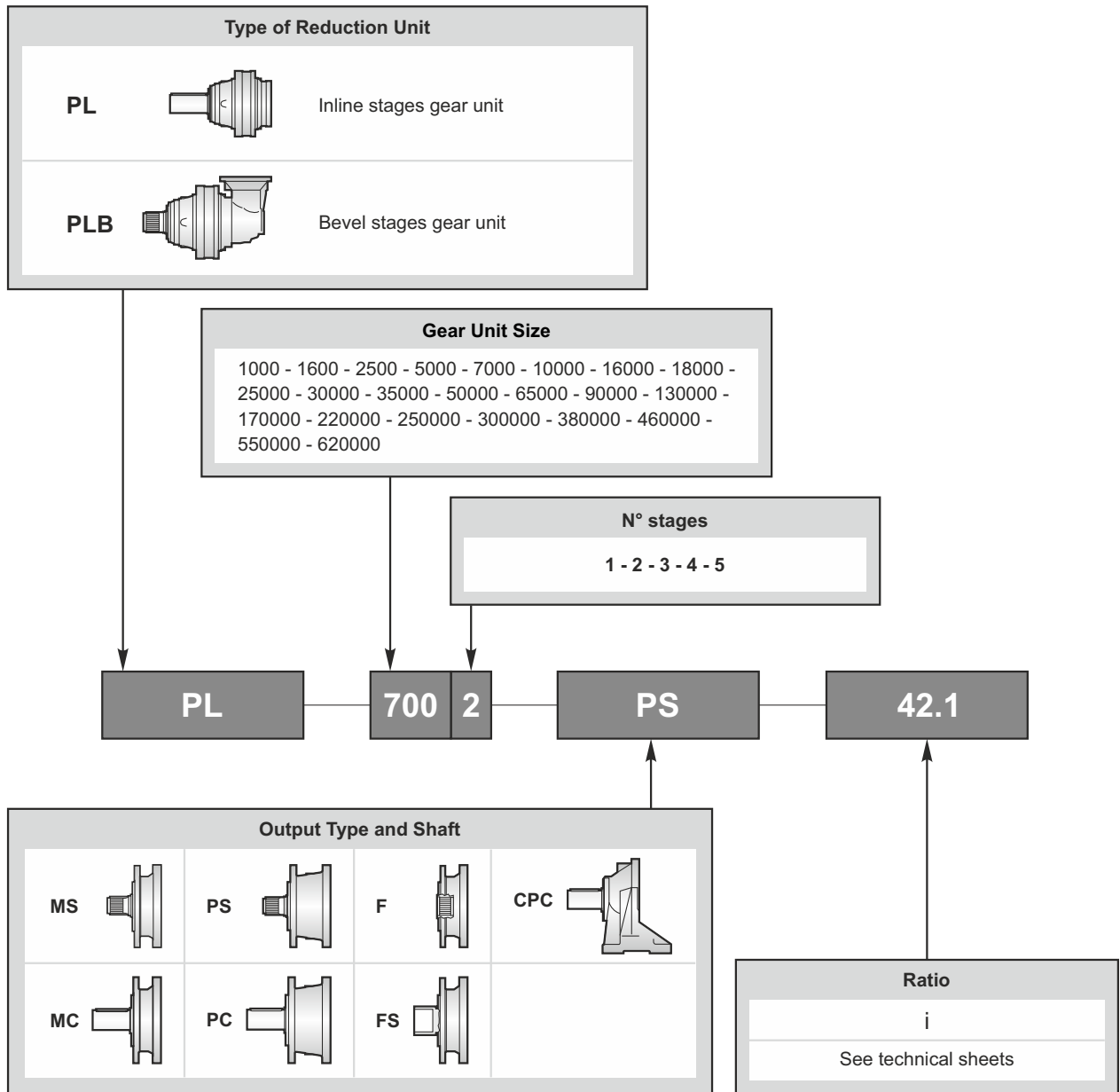

2.2 Explanations

Table 2: Product Description (Explanations)

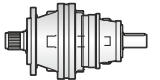

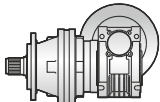
EXAMPLE FOR ORDERING	
PL 7002 PS 42.1 IEC90 B5 YZ FF	
PL 7002 PS 42.1 EML 42 B5	
PL 7002 PS 42.1 H.2074.013.018 B5 FL FF	
PL 7002 PS 42.1 PMRV63 20 90B14 C1	



Accessories

Table 3: Product Description (Accessories)

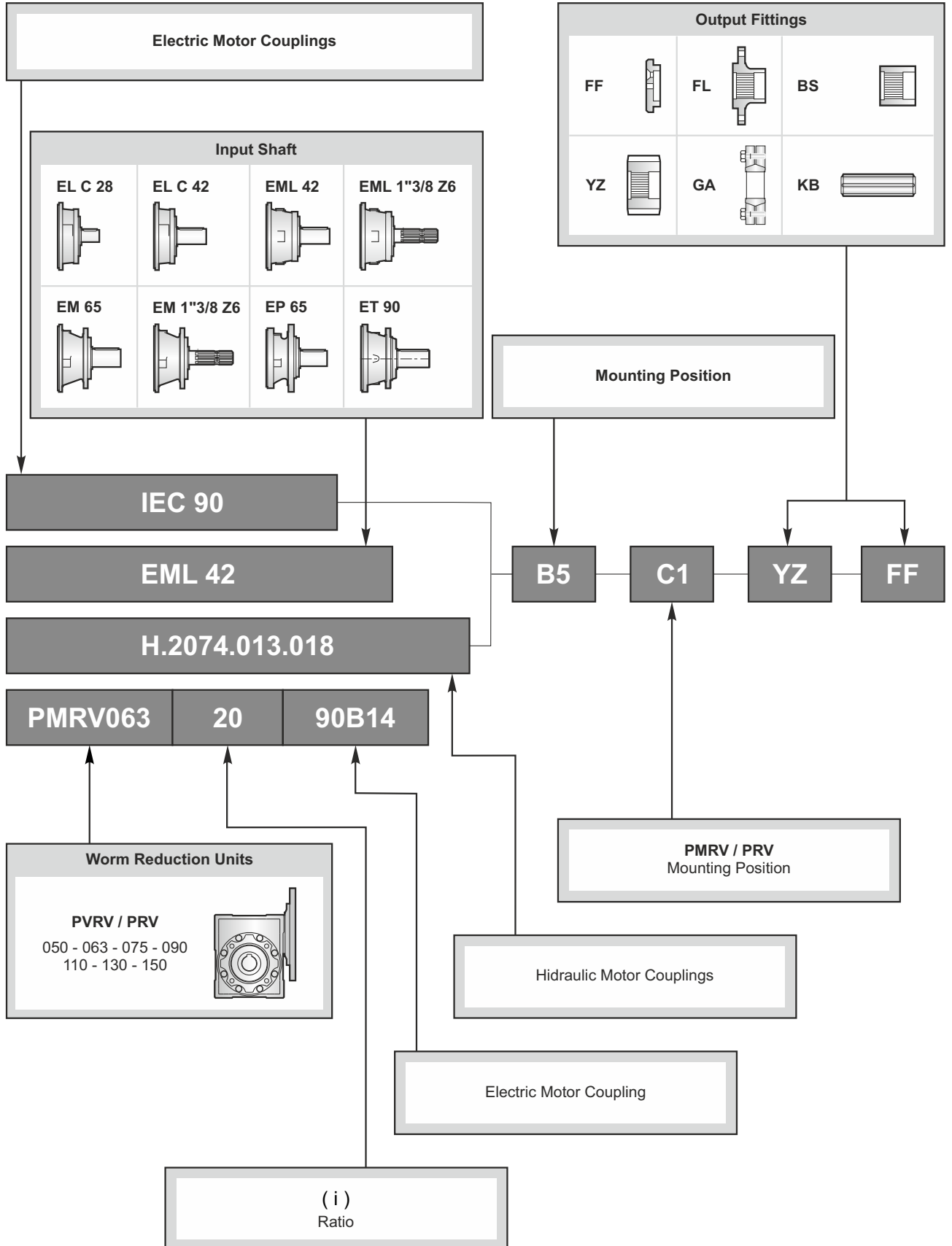



2.3 Abbreviations

Table 4: Abbreviations

Abbreviations	Meaning	Planet Gear Units
PL	Coaxial Gear Unit	✓
PLB	Bevelled Gear Unit	✓
MS	Mounting Flange and Splined Shaft	✓
MC	Mounting Flange and Keyed Shaft	✓
PS	Mounting Flange and Heavy Duty Splined Shaft	✓
PC	Mounting Flange and Heavy Duty Keyed Shaft	✓
F	Mounting Flange and Splined Hollow Shaft	✓
FS	Mounting Flange and Hollow Shaft	✓
CPC	Foot Mounted and Keyed Shaft	✓
ED	Direct Input Motor Adaptor Without Brake	✓
EDF	Direct Input Motor Adaptor With Brake	✓
EF	Direct Input Motor Adaptor With Brake	✓
RA - RB	Brake	✓
YZ	Pinion	✓
BS	Spline Coupling	✓
FL	Flange	✓
FF	Fixing Washer	✓
KB	Spline Shaft	✓
GA	Shrink Disc	✓
ELC - EML - EM - EP - ET	Input Shaft	✓
IEC	IEC Adapter	✓
PMRV	Worm Gear Unit Adaptors	✓

✓ : Existing designs are marked with a tick.



3.1 Prerequisites of Assembly

Take into the consideration which listed below;

- The informations placed on gear unit with motor in accordance with current network voltage.
- There could be no damage in the gear unit.
At standard gear units;
- The ambient temperature should be fitted temperature values given in the 'Lubricant' part.



DANGER !

The Gear unit must not be mounted in the ambient conditions listed below:

- Explosive atmosphere, high corrosive and/or oils, acids, gases, steams, radiation,
- Places directly contacted to the food.

At special applications the configuration of gear unit/gear unit with motor are realized convenient to the ambient conditions. Output shafts, processed surfaces, corrosion preventive material on the solid shaft/hallow shaft, jerks etc. must be cleaned.

Extensive usage-solvent must be used. The solvent should not be contacted to the bearing houses and sealing components.

In the abrasive ambient conditions, both output shaft, sealing components must be protected to the wearing Connection flanges must be attached to the hollow shaft/solid shaft according to DIN 332.

The situations where the wrong direction of rotation could caused to damages and dangers, before the mounting, the test work should implemented to the gear unit so the right direction of rotation could be determined and must got into the secure for the next operating.

In the one-way locked gear units, nibs are placed at the entry and exit side of the gear unit. The ends of the nibs shows the direction of rotation of the gear unit. During the motor connection and motor-operating with the help of magnetic field, the gear unit must be operated just at the direction of rotation.



DANGER !

In the one-way locked gear units, the gear unit must be operated at the direction of lock rotation, otherwise the damage could be occurred.

Around the mounting position, there must be sured that there are not any materials fused to metal, lubricating tool or elastomers which causes corrosion or will not be emerged.



3.2 Gear Unit Mounting

The lifting eyebolts screwed to gear unit must be used in gear unit mounting.

- Mounting of gear unit/gear unit with motor to the machine and selection of mounting place are crucial.
- The convenient connection points must be determined for gear unit type. (Foot mounted or Flange mounted)
- Ventilation plug must be opened after the carrying process.
- The connection tools which attached during the mounting to the machine must be tightened convenient to the torc given at the table.
- Because of the voltage, for to avoid transferring additional forces to the gear unit, both the gear unit and driven machine shaft must be aligned.
- There should not be any welding process on the gear unit. In the welding processes, the gear unit must not be used as a bracket. Otherwise bearing and gear part could damaged.



ATTENTION !

During the mountage, the voltage should not be emerged between the foot and flanges and allowed radial and axial forces would not be taken into consideration! Check whether if there is radial or axial leakage at the connection unit which is between PAM and output shaft.

- The gear unit/gear unit with motor only could be mounted according to determined mounting position. After the delivery, in the case of changing mounting position the change of lubrication level and other precautions could be needed. Any failures to comply to the determined mounting position could damaged gear unit.
Please consult to PGR.
- The gear unit/gear unit with motor have to be structured to stand against motor weight and operating voltages. The machine which will be connected has to be structured to stand against the weight of the gear unit with motor and operating voltage. The surface where the gear unit is to be fixed must be straight, vibrationless and protected against torsion.
- The machine which gear unit/gear unit with motor will be connected, there must be sured that it is closed and not to be operated without intention.
- The sphere of the movable pieces out of the gear unit must be closed with the safety cabinet kit.
- The sunlight and the impact of the weather conditions must be prevented during the mountage of the gear unit to the outside machine. However the air circulation needed to be provided to the unit.
- Depending on the type of used gearbox, all the foot and flange bolts must be used completely. Bolts must be tightened with proper tightening moments.



NOTE !

The opportunity of the easy access must be provided to the oil level plug, drain plug and ventilation plug.

The proper oil filling should be controlled according to mounting position. (Could be viewed on 'lubricators/oil filling quantities' part or the values written on gear unit) The necessary amount of oil has filled to the gear unit/gear unit with motor by our firm. The slight deviations in oil level plug are resulted because of the mounting position and within the production tolerances.

If there is any danger of the electro-chemical corrosion between gear unit and machine, plastic pieces (2-3 mm) must be mounted between the connections. The electrical discharge resistance of used plastic material must be $<10 \Omega$.

Electro-chemical corrosion could be occurred between the different metals like cast iron and stainless steel. Also plastic washer should be used in bolts!



3.2.1 Bolt Tightening Torque Value

Table 5: Bolt Tightening Moments

Bolt Tightening Moments [Nm]						
Dimensions	Bolt Quality			Cover Bolts	Coupling Bolts	Protective Cover Connection Bolts
	8.8	10.9	12.9			
M4	3.2	5	6	-	-	-
M5	6.4	9	11	-	2	-
M6	11	16	19	-	-	6.4
M8	27	39	46	11	10	11
M10	53	78	91	11	17	27
M12	92	135	155	27	40	53
M16	230	335	390	35	-	92
M20	460	660	770	-	-	230
M24	790	1150	1300	80	-	460
M30	1600	2250	2650	170	-	-
M36	2780	3910	4710	-	-	1600
M42	4470	6290	7540	-	-	-
M48	6140	8640	16610	-	-	-
M56	9840	13850	24130	-	-	-
G½	-	-	-	75	-	-
G¾	-	-	-	110	-	-
G1	-	-	-	190	-	-
G1¼	-	-	-	240	-	-
G1½	-	-	-	300	-	-

3.3 Gear Unit Ventilation

In moist places or in open air usage, the gear unit which is resistant to corrosion is recommended. The damages in paint (in ventilation plug) must soon be corrected.

The carrying safety of the ventilation plug on the gear unit is to be remove. If ventilation plug was sent seperately, it has to be inserted.

Figure 3: Activation of Vent Plug

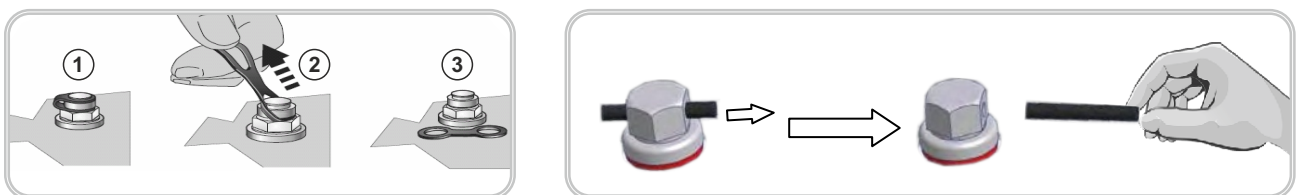

1. The carrying secured ventilation plug,
2. Remove the carrying safety,
3. The ventilation safety is active.



3.4 Retrospective Paintwork

If you paint over all or part of the drive, please take care to mask the breather valve and oil seals carefully. Remove the masking tape once you have completed the painting work.

3.5 The Mountage of the Connection Tool to the Output Shaft

For the mountage of the output shaft tools look at the schema below.

Figure 4: The Mountage of the Connection Tool to the Output Shaft

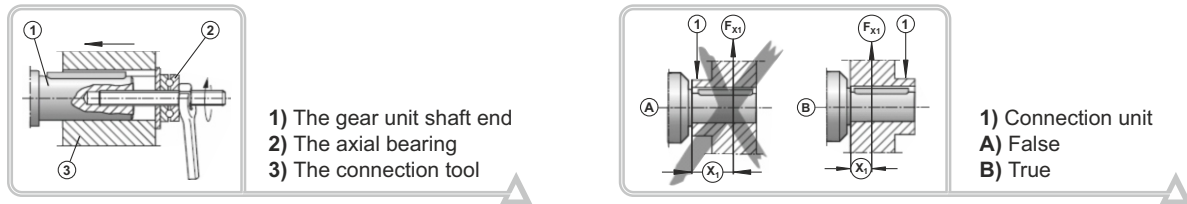

* To prevent high radial forces: the gear and sprocket must be mounted as seen in shape B.

For the mounting of the connection tools only pulling device must be used. For the position adjustment the bearing strip which is at output shaft end must be used.

	<p>NOTE !</p> <p>The belt and pulleys, couplings, gears and etc. Must not be installed with hammering to the shaft end. Otherwise there could be a damage in body, bearings and shaft. In belt and pulleys, the rightness of the belt voltage must be paid attention. (suitable to the producer's data). For the not emerging of disallowed radial and axial forces, balance adjustment of the connection tool must be made.</p>
	<p>NOTE !</p> <p>With smearing a little amount of grease or heating the connection tool in a short-time (80....100), the mounting easiness may be provided.</p>

3.6 The Mountage of the Couplings

While the couplings are mounting, it's balances must be made suitable to the datas of the producers. Must be implemented with suitable clamping device. Before mounting with the smearing of corrosion oil material to the solid output shaft/hollow shaft, mounting and demounting processes may be eased.

Figure 5: The Mountage of the Coupling

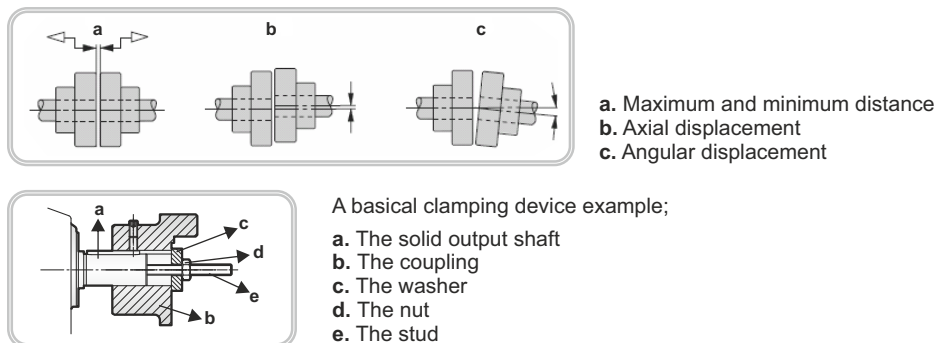

	<p>ATTENTION !</p> <p>The belt-pulley, chain and gear drives must be protected from the contact of the external effects.</p>
--	---



3.7 The Mountage of the Standard B5 Motor to the PAM Gear Unit

1. The motor and the solid output shaft of the motor with PAM adapted, flange surfaces must be cleaned and damage control must be made. The sizes and tolerances of the motor fixing elements must be suitable to EN 60079-0.
2. Must be pushed till to stand to the block of motor solid output shaft.
3. If the mountage is to be done in open air and the environment is wet, it is recommended that the surfaces of the motor flange and PAM adaptor have to be isolated. Before and after the motor mounting, in the shape of flange is isolated, loctite 574 or loxeal 58-14 surface isolation material should be used to flange surfaces.
4. The motor, must be installed to PAM adaptor.
5. The bolt of the PAM adaptor has to be mounted with suitable tightening moment.

3.8 The Demountage of the Electrical Motor (PAM)

During the operating, it is crucial that the surface of the connection tool between the motor and gear unit is not rusted, for the removal of the motor not to exercise excessive load is necessary. During the separation of motor from the gear unit without forcing, the method at the below must be implemented. Must be avoided the implementations that causes strain and harm to the gear unit.

Figure 6: The Demountage of the Electrical Motor (PAM)

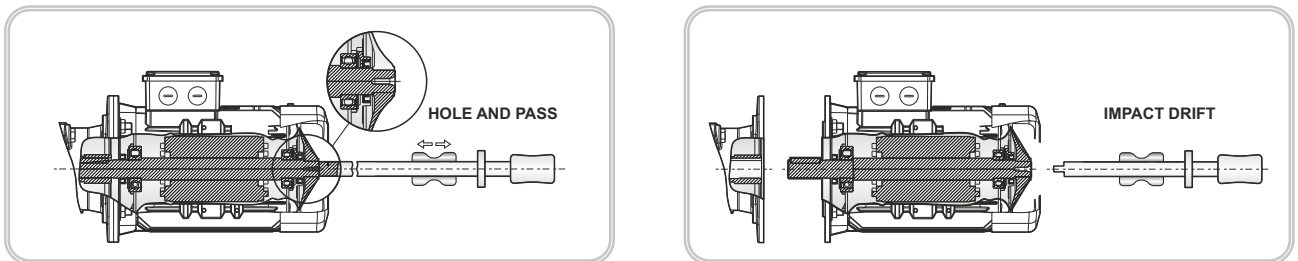

1. By fan with drilling the motor solid output shaft, the thread cutting must be opened.
2. The impact drift has to be installed to the threaded place.
3. The connection screws between the motor and gear unit must be removed.
4. By the help of impact drift inertial force, the motor must be separated from the gear unit.

The use of slots in the body of PAM, with the help of screwdriver or lever in a way that the motor is not harmed, may be removed by pushing back.

3.9 Gear Unit Operating

- The gear unit is tested firstly at our firm. (leakproofing test, noise test, torc test)
- For the confirmation of direction of rotation of gear unit, it is needed to be operated before machine mounting.
- The mounting of gear unit to the machine is needed to be convenient to 2006/42/EC and other safety standards.
- The electrical motor is needed to cover EN 60204-1 and EN 60079-0 standard.
- The mounting position of the gear unit should be as same as tag values.
- The datas in power units should be tolerated (plus, minus) %10 according to values specified in tag.
- There must not be any oil leakage in gear unit.
- There must not be extremely vibration and must not exceed acceptable voice decibel for gear units.
- In the situation of long-term non-usage, the storage conditions are needed to be implemented.
- The oil position must be controlled for the mounting position specified in catalogue.
- The oil level must be controlled.
- Before the operating, the carrying safety of the ventilation plug on the gear unit is needed to be removed.
- If the gear unit is dispatched without oil, the first oil filling must be loaded according to oil quantity stated in oil tables.
- It is not allowed to operate in sensitive areas against explosion. For these conditions, specific motors are available. Please consult to our firm.



4.1 Control and Periodic Maintenance

	<p>NOTE !</p> <p>The maintenance and periodic maintenance works are performed by qualified person/operator who is well-educated and is sufficient in electric and mechanic issues; the rules convenient to job health and safety and specific environmental problems are performed as protected.</p>
--	---

	<p>DANGER !</p> <p>Before the start of the maintenance work of the gear unit, gear unit should be closed at first (get into the voltage-free position), be sured service-free, needed to take measures against any accident or spinning items with the help of unexpected external load. Also all environmental safety precautions must be taken.</p>
--	--

- Before the maintenance process, all safety equipments are needed to get ready and if necessary the outside personal should be warned. The border around the unit must be specified and must prevented equipment entrance to the area. If any failures to comply to these conditions, the situations which causes harm to health and safety could be occurred.
- Worn items only must be changed with original and unused items.
- The lubricators, which recommended by our company, should be used. (see. **6.2 Lubrication Table**, page 40)
- The leakproofing items on the gear unit must be changed with original items.
- If the bearing is needed to be changed please contact to our firm.
- After the maintenance work, we recommend to change the lubrication oil.

All above informations were given for the purpose of efficient and confidential operating of gearboxes. Our firm is not responsible for substitute product and unroutined maintenance that causes damages and woundings. When purchasing gear unit, should be noted that it is original product and has technical informations written in catalogue.

	<p>NOTE !</p> <p>The polluted oil and rusted items must not be left to the environment after the maintenance. These items must be disposed convenient to the regulations.</p>
--	--

Table 6: Control and Periodic Maintenance Ranges - Works

Control and Periodic Maintenance Ranges	Control and Periodic Maintenance Works
Once at every 3000 work hours or once at every 6-months until the	<ul style="list-style-type: none"> - Visual inspection - Check for running noises - Check oil level
80 work heat. Once at every 10.000 work hours or once at least in two years (the synthetic oil is once at every 20.000 work hours or once at every four years)	<ul style="list-style-type: none"> - Change the oil - The change of the ventilation plug
At least every 10 years	<ul style="list-style-type: none"> - General overhaul.



4.2 Visual Inspection

Controlling whether there is any oil leakage exists or not should be made at gearbox.

There must be controlled that if there is oil filled or not in gear unit. Should be controlled that if there is any damage in gear unit's items and whether if the connection spots are rusted.

Also must be controlled that if any cracks could emerge in hose connection lines and in rubber wedges.

Leakproofing likes of dripping of gear unit's oil or dripping of cooling water and in damages and cracks, repair of the gear unit must be provided. Like these situations please get in contact with PGR.

Because of the storage and carrying, before the operation of gear unit and during at first operation, low amount of grease could flow out from bearing, this type of oil leak could not create any technical failure, the safety of gear unit and bearing operation could not be effected.

**NOTE !**

Must be sured that there is not air in hydraulic circuit.

4.3 Check for Running Noises

The emerge of unusual operation voice or vibrations in gear units could mean damages. In this type of situations, the gear unit must be stopped and overall revision must be made.

4.4 Control of the Lubricant and Lubricant Level

- Regular oil level controlling must be made.
- The electrical connection of motor must be cut and must got into safety form to prevent for reactivating.
- Must be waited until the gear unit got cooled.
- If the mounting position is changed, the section of "the mounting of gear unit" must be got into attention.
- A little amount of oil must be taken out of the oil drain plug. The quality of oil must be controlled.
- The oil must be changed when the sign of extremely oil pollution is seen.

4.5 Changing the Oil

To prevent the emergence of the danger of burning, must be waited until the gear unit got cooled. The oil level, draining and position of ventilation plugs are dependent on mounting position. For the mounting position, related pages from catalogoue could be seen. When the oil-changing process, the gear unit should be at operating temperature. The electric connection of motor driving unit must be cut and got into safety for re-activation.

**NOTE !**

Because of the coldness of oil will affected the flowing and venting, the gear unit must not be cooled fully.

**NOTE !**

Below articles should be made respectively in the oil changing of hydraulic brakes. The reason is; oils of hydraulic brakes are different from gearboxes's one.

If the gear unit mounted vertical, the oil change must absolutely made from the expansion tank which is attached to gear unit.

After 100 hours,first oil change must be made.



Changing the oil;

- Oil level plug, oil draining plug and ventilation plug must be removed.
- Both the oil is completely drained and the cleaning of gear unit must be made with proper solvent.
- The leakproofing elements on gear unit must be changed with original items.
- The oil draining plug must be put back to it's own place again.
- If the oil draining and level plug's gear part are damaged, instead of these, the new plug must be used.
- Before putting on the plugs, the sticky must be applied to the gear part like Loctite 242. If the aluminum washer is damaged, the new one must be used.
- The aluminum washer must be put lower and oil draining bolt must be bolted with proper moment.
- The oil according to mounting position must be filled from the vent hole with the proper draining device to the amount which is shown in catalogue. (could be filled from hole which is on the oil level). If the oil type is changed. Must be consulted to our firm.
- After the filling process, all plugs should be closed.
- 30 minutes after the oil filling, oil level must be controlled.

At high temperatures or at hard working conditions (high humidity, corrosive environment or high temperature fluctuations), the oil changing ranges must be reduced by half.

4.6 Oil Plugs Squeezing Torc Chart

Table 7: Oil Plugs Squeezing Torc Chart

Plug	Torc [Nm]
1/4"	7
3/8"	7
1/2"	12

4.7 Change of the Ventilation Plug

In excessive pollution situations, ventilation plug must be dismantled and got cleaned or with aluminum washer, the new ventilation plug must be mounted.

4.8 Change of the Oil Seal and Oil Cover

- The electric connection of motor drive unit must be cut and got into safety for mistakenly re-activation.
- At the time oil seal is changing, the sufficient amount of grease must be found between leakproofing lips and should be paid attention that the surface is not dirty and dusty.
- When the double seal is used, 3/2 of the part which remained between two seal must be filled with grease convenient to the oil type inside the gear unit.
- During the change of the oil seal the proper devices must be used for not to harm the body and shaft.
- During the change of the oil seal and oil filler cup, the original product must be used.



4.9 The Bearing Greases

- To the bearings of motorized gearboxes, greases should be used which are available at the grease table given by our company.
- Our company (PGR) recommends also replacing of grease while changing lubricant at the greased bearings.

4.10 General Overhaul

The gear unit must fully be dismantled and works written below have to be done respectively.

- All parts of the gear unit must be cleaned.
- The damage control must be done to all parts of the gear unit.
- The damaged parts must be changed with original part.
- All roller bearings must be changed.
- If there are, locks must be changed.
- All oil seals and nilos caps must be changed.

All plastic and elastomer parts of the motor coupling must be changed.



NOTE !

The general revision should be made by the qualified personnel with considering the international laws and regulations in the plants which has the required equipments. We recommend that the general revision has to be made at the PGR service.

4.11 The Maintenance of the Motor

Our firm recommends to change the grease in greased bearings.

Before the start of motor maintenance, the operator should closed the unit, must be sured that it is out of service and must taken all the measures against any accident or unexpected load.

- To prevent overheating, if there is, the dust coat on it must be cleaned.
- The bearings must be dismantled, cleaned and greased.
- By 1/3 of bearing, the grease must be used.
- The proper grease must be selected from the oil tables.
- Motor oil seals must be changed.



5.1 Mounting Positions

Install the gearbox at the projected moutage position. For the other moutage positions except this one, please consult to our Technical Service.

Figure 7: Mounting Positions

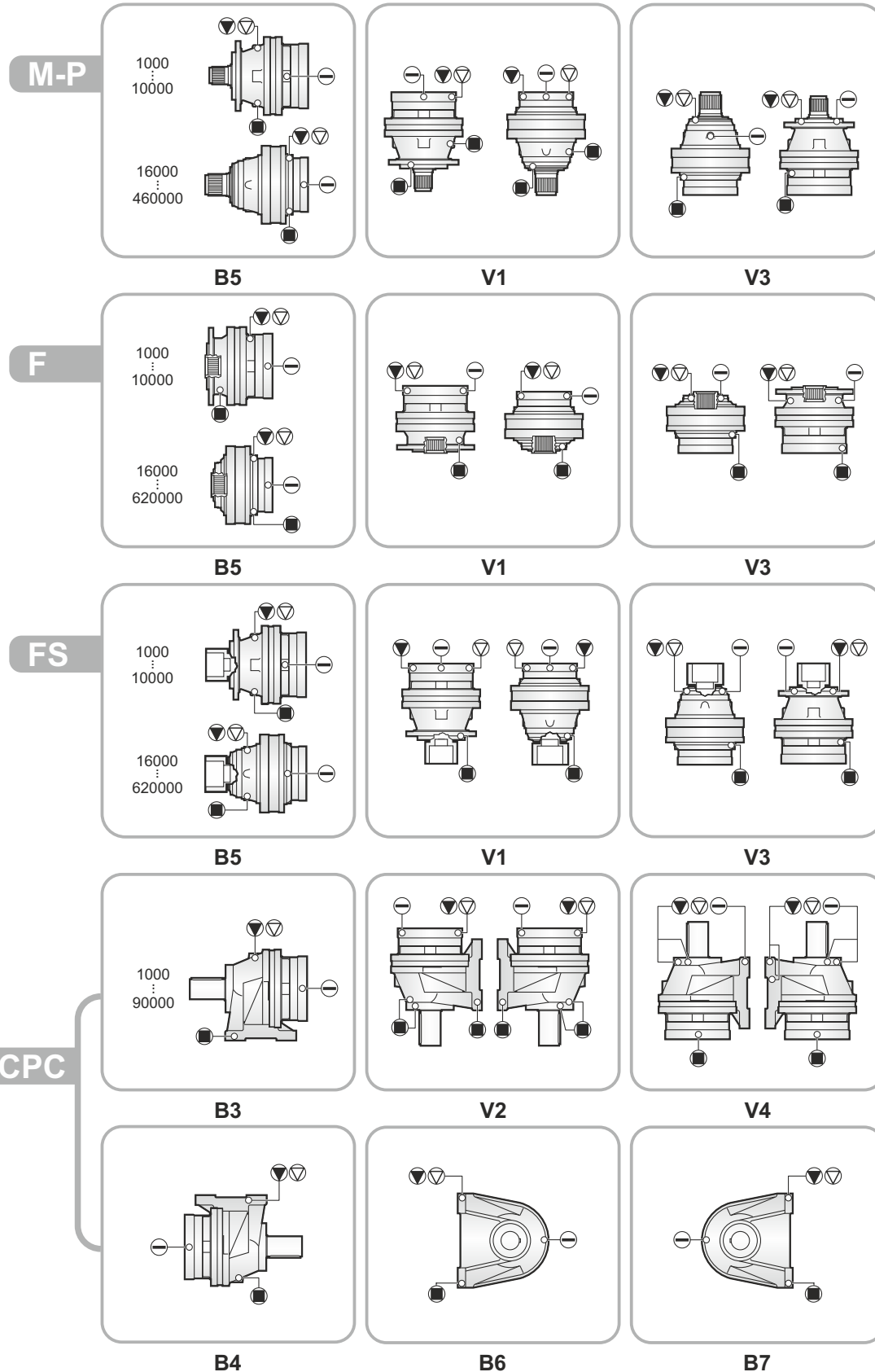

Filling Plug

Vent Plug

Oil Level Plug

Drain Plug



M-P

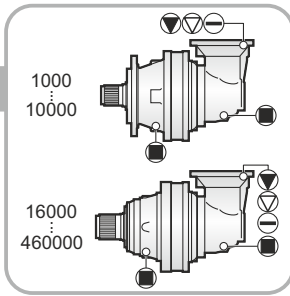

B51

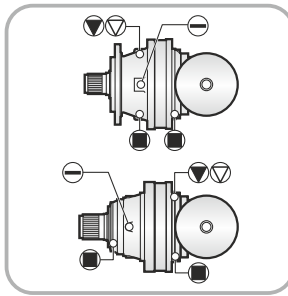

B55

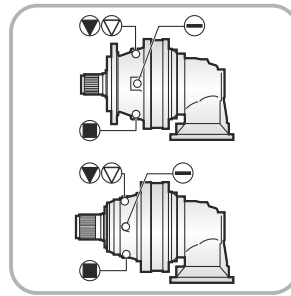

B53

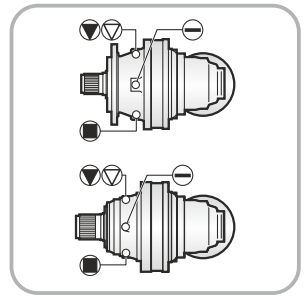

B54

F

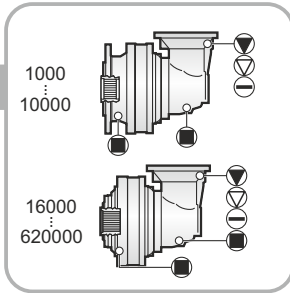

B51

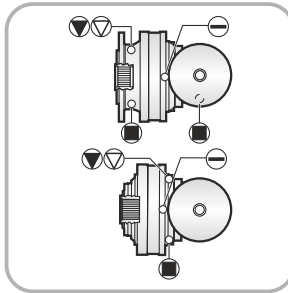

B55

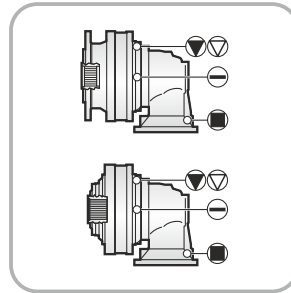

B53

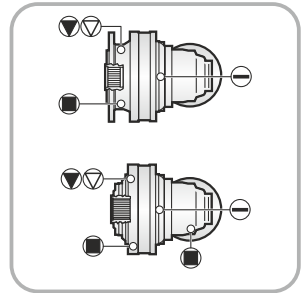

B54

FS

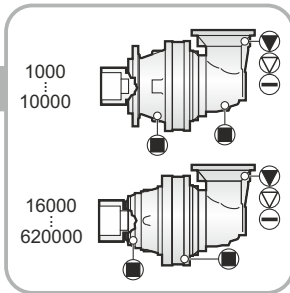

B51

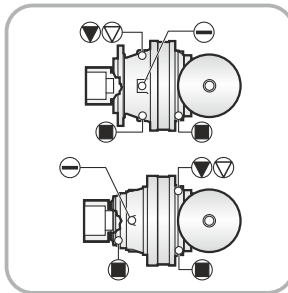

B55

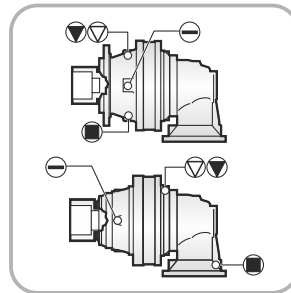

B53

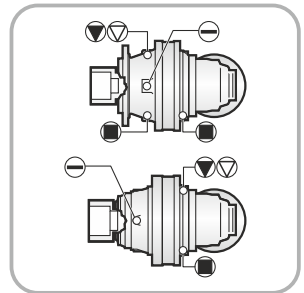

B54

CPC

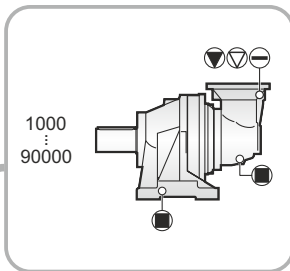

B56

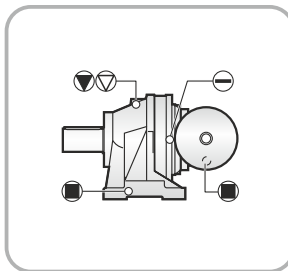

B60

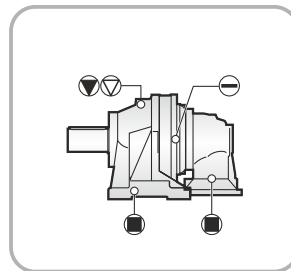

B58

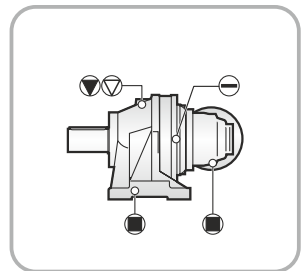

B62

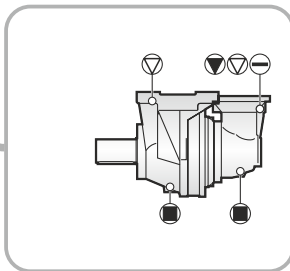

B57

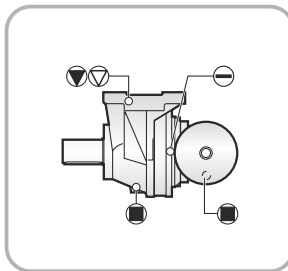

B61

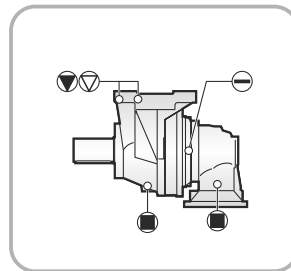

B59

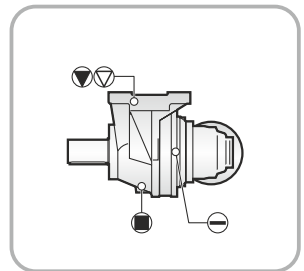

B63



Filling Plug



Vent Plug



Oil Level Plug



Drain Plug



M-P

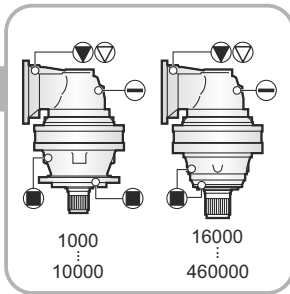

V15

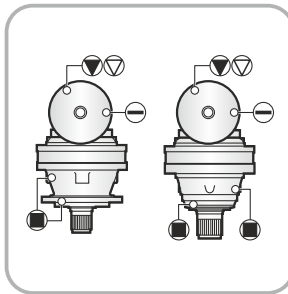

V16

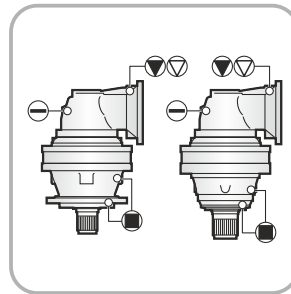

V17

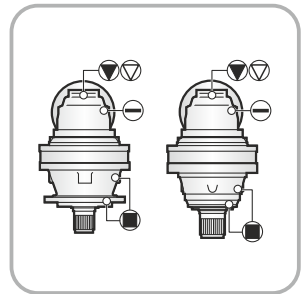

V18

F

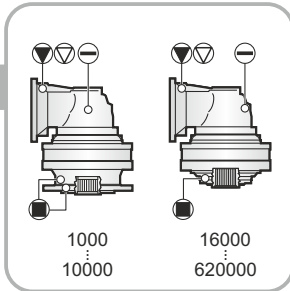

V15

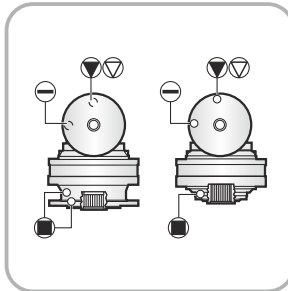

V16

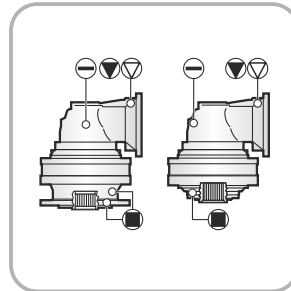

V17

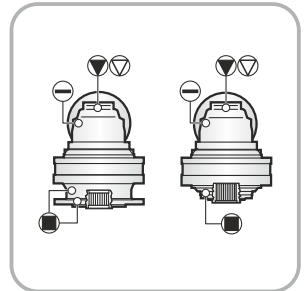

V18

FS

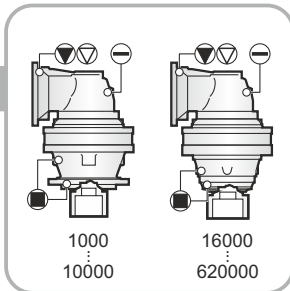

V15

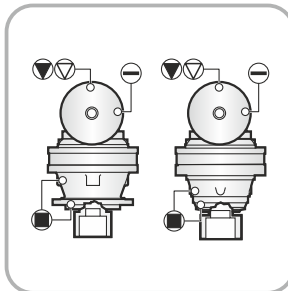

V16

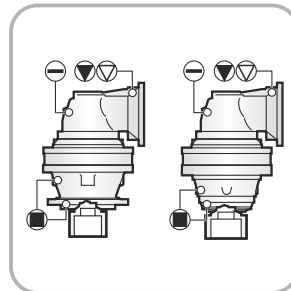

V17

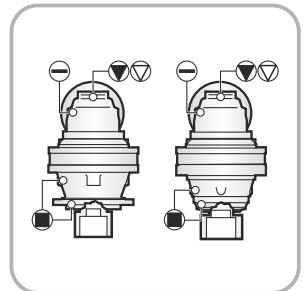

V18

CPC

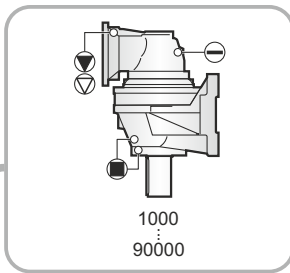

V53

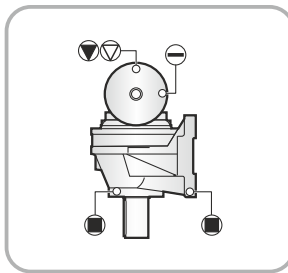

V52

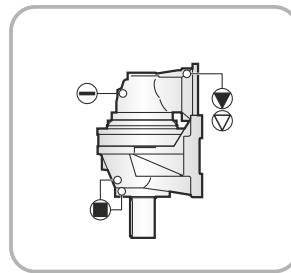

V54

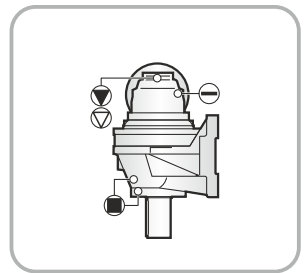

V55

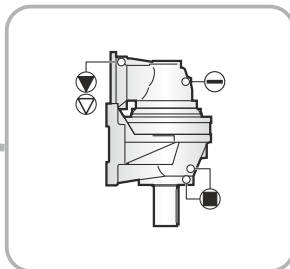

V49

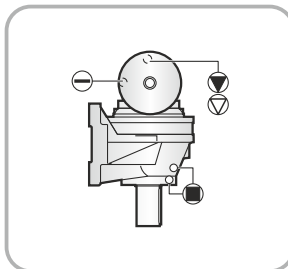

V48

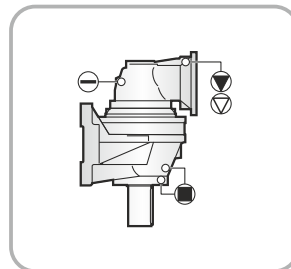

V50

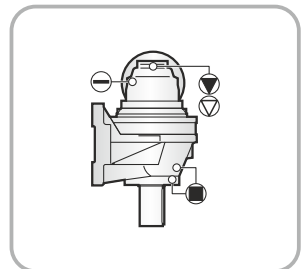

V51





M-P

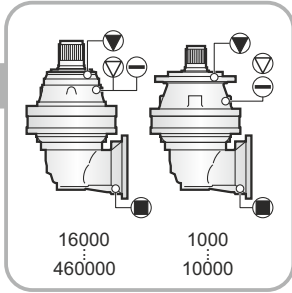

V35

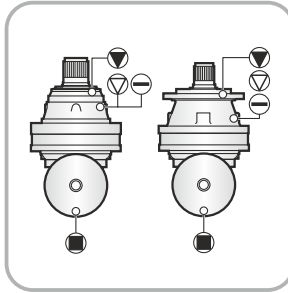

V36

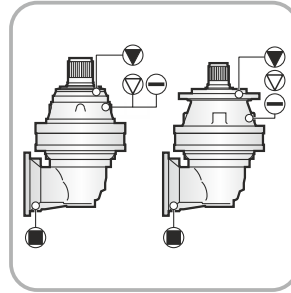

V37

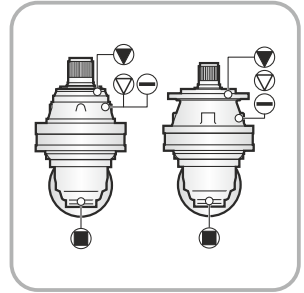

V38

F

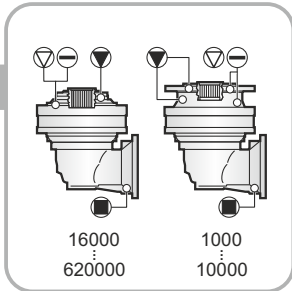

V35

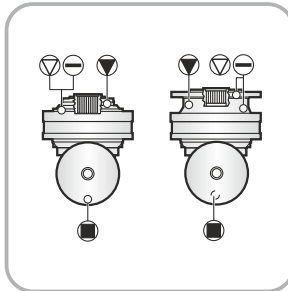

V36

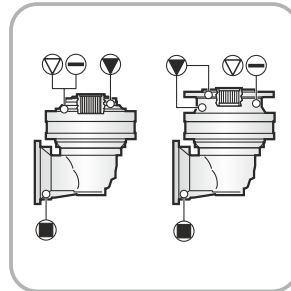

V37

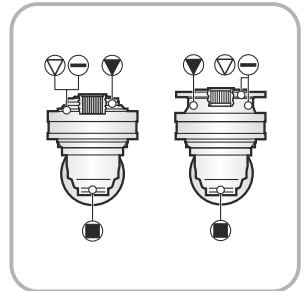

V38

FS

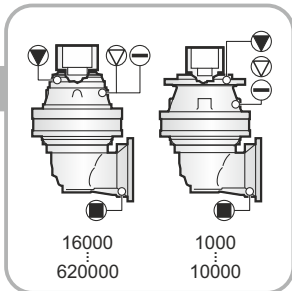

V35

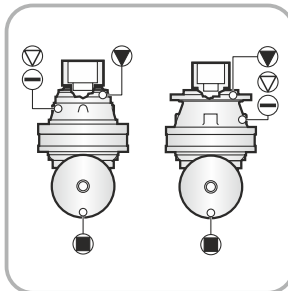

V36

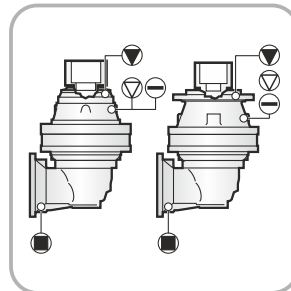

V37

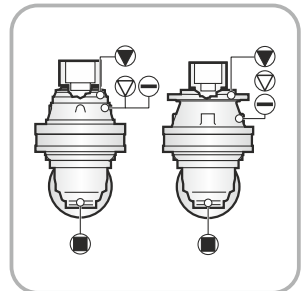

V38

CPC

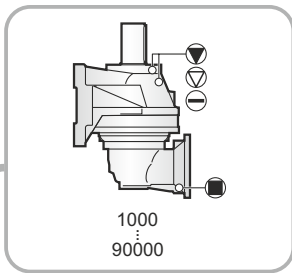

V42

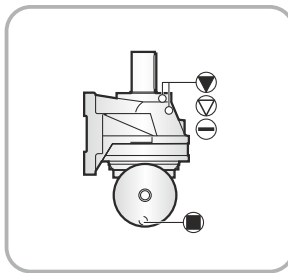

V40

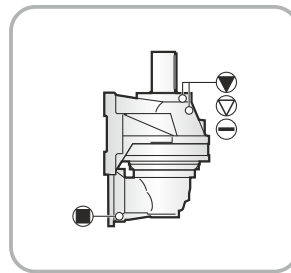

V41

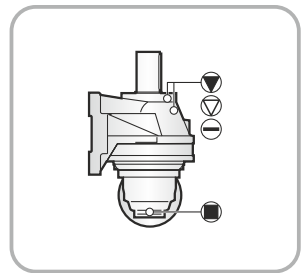

V43

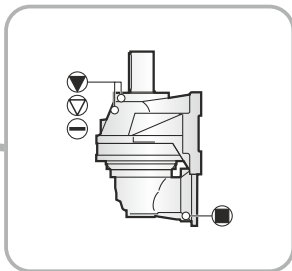

V46

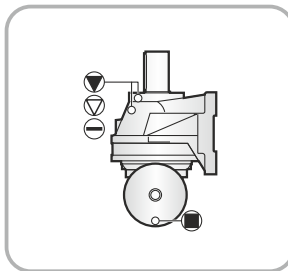

V44

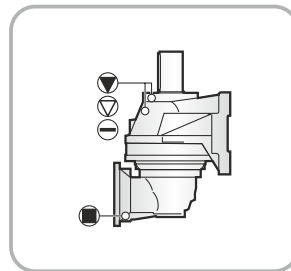

V45

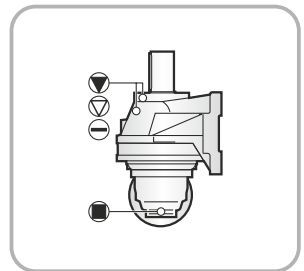

V47





F

M

P

FS

CPC

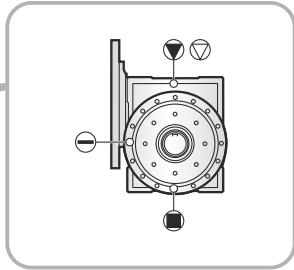

C1

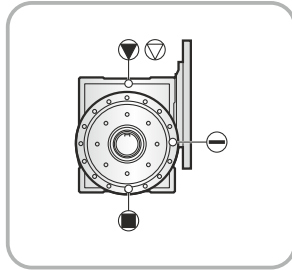

C2

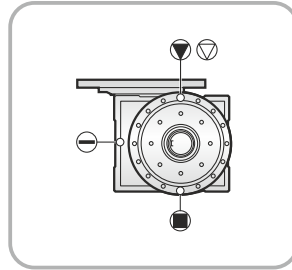

C3

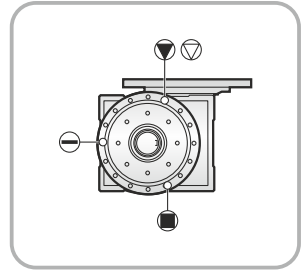

C4

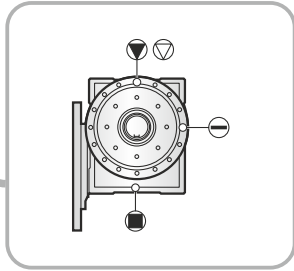

C5

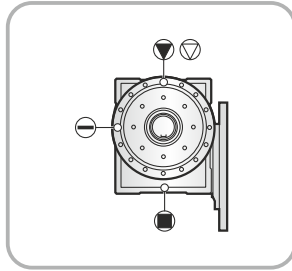

C6

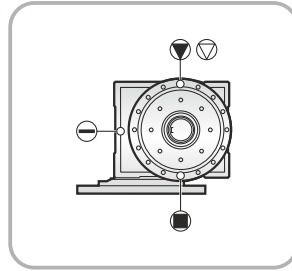

C7

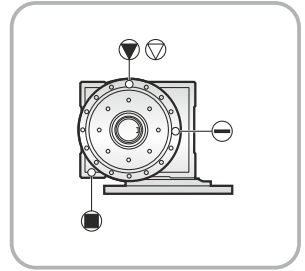

C8

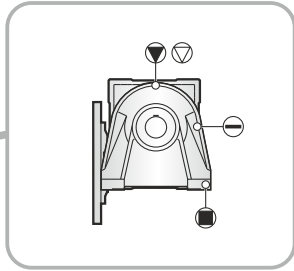

C9

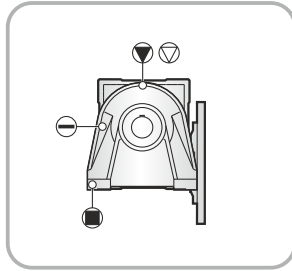

C10

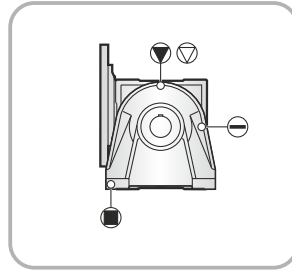

C11

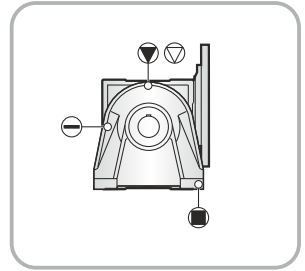

C12

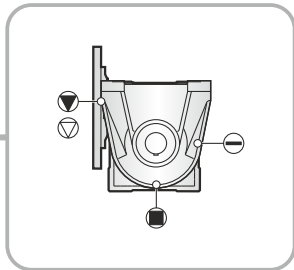

C13

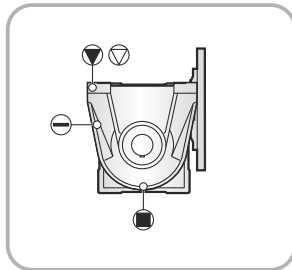

C14

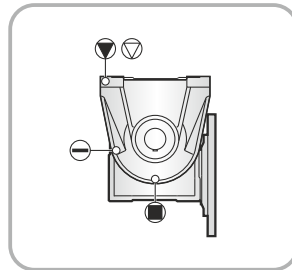

C15

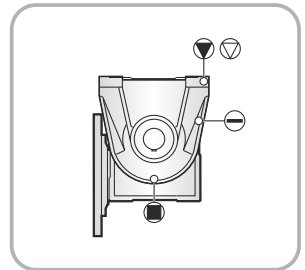

C16

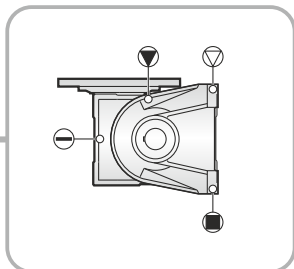

C17

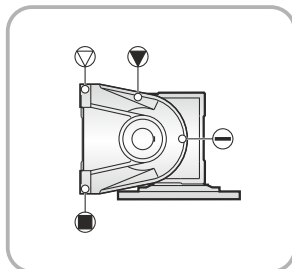

C18

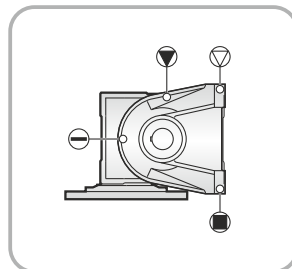

C19

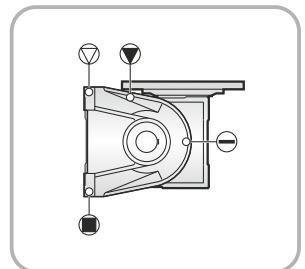

C20

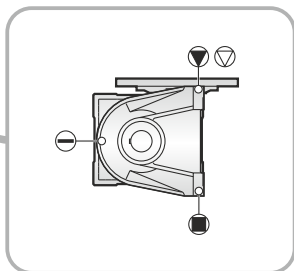

C21

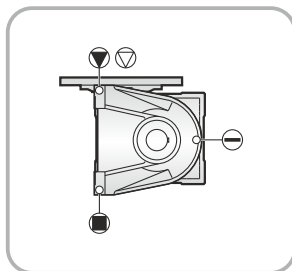

C22

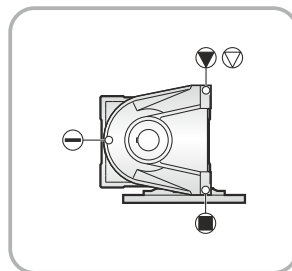

C23

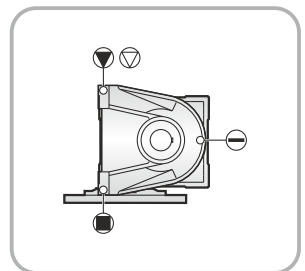

C24



Filling Plug



Vent Plug



Oil Level Plug



Drain Plug



6.1 Lubrication

PL / PLB series are lubricated with gear unit rinsing.

ISO VG 220-viscosited and EP mixed mineral oil must be used. The oil types which could be purchased from the oil producers are given at the table below.

During the operating, the exterior surface temperature must not be over 90. If the temperature exceeds this, must be contacted with PGR technical service.

For ensuring the smooth running of the gear unit, the correct lubricating is essential; therefore at the mounting stage the following situations must be controlled:

- In compliance with the mounting position stated at order, must be controlled that whether the plugs are inserted correctly in pursuant of given informations.
- If the gear unit is mounted horizontal, must be filled at half, regardless of it's linear or angular position. With dismantling of the plug which is at or over that area, the oil level must be eye-controlled.
- At the bevel gear unit orders (angular gear unit) with holding both pieces (only if they are same) at the intended mountage position, having the oil filling on the ground is recommended. Thus the filling will be getting fast and at the same time, as the time flows while passing from one division to another you would know that you have put the oil at the right quantity.
- If the gear unit is mounted vertical, by using of elbows and expansion tanks which sent with the gear unit, the oil must be filled from above. Using the expansion tank at these positions is recommended by PGR.

	NOTE !
	In continuously operating gear units because of the oil in it, it may be exposed to overheating. In these situations the use of lower viscosited oil is recommended by PGR.

6.2 Lubrication Table

Table 8: Lubrication Table

LUBRICATION									
	Mineral Oil			Poly - Alpha - Olefin Synthetic Oils (PAO)			Polyglycol Synthetic Oils (PG)		
Ambient Temperature	-10°C +30°C	+10°C +45°C	+30°C +60°C	-20°C / +60°C			-20°C / +60°C		
MANUFACTURER	ISO VG 150	ISO VG 220	ISO VG 320	ISO VG 150	ISO VG 220	ISO VG 320	ISO VG 150	ISO VG 220	ISO VG 320
AGIP	Blasia 150	Blasia 220	Blasia 320	-	Blasia SX 220	Blasia SX 320	Blasia S 150	Blasia S 220	Blasia S 320
BP	Energol GR-XP 150	Energol GR-XP 220	Energol GR-XP 320	Enersyn EPX 150	Enersyn EPX 220	Enersyn EPX 320	Enersyn SG 150	Enersyn SG 220	Enersyn SG 320
CASTROL	Alpha SP 150	Alpha SP 220	Alpha SP 320	Alphasyn EP 150	Alphasyn EP 220	Alphasyn EP 320	Alphasyn PG 150	Alphasyn PG 220	Alphasyn PG 320
CHEVRON	Ultra Gear 150	Ultra Gear 220	Ultra Gear 320	Tegra Synt. 150	Tegra Synt. 220	Tegra Synt. 320	HiPerSYN 150	HiPerSYN 220	HiPerSYN 320
ESSO	Spartan EP 150	Spartan EP 220	Spartan EP 320	Spartan S EP 150	Spartan S EP 220	Spartan S EP 320	Glycolube 150	Glycolube 220	Glycolube 320
KLUBER	Klüberoil GEM 1-150	Klüberoil GEM 1-220	Klüberoil GEM 1-320	Klübersynth EG 4-150	Klübersynth EG 4-220	Klübersynth EG 4-320	Klübersynth GH 6-150	Klübersynth GH 6-220	Klübersynth GH 6-320
MOBIL	Mobilgear XMP 150	Mobilgear XMP 220	Mobilgear XMP 320	Mobilgear SCH XMP 150	Mobilgear SCH XMP 220	Mobilgear SCH XMP 320	Glygoyle 22	Glygoyle 30	Glygoyle 22
SHELL	Omala 150	Omala 220	Omala 320	Omala HD 150	Omala HD 220	Omala HD 320	Tivela S150	Tivela S220	Tivela S320
TOTAL	Carter EP 150	Carter EP 220	Carter EP 320	Carter SH 150	Carter SH 220	Carter SH 320	Carter SY 150	Carter SY 220	Carter SY 320

It is forbidden to use different kind of oil without the approval of the PGR technical service



7.1 Expansion Tank

At the vertical mountages, using expansion tank at higher than the peak point of the gear unit is recommended by PGR.

It's duty is to retain oil expansion and providing to make the oil support to unreachable points.

This appurtenance is sent separately from the gear unit upon request.

Figure 8: Expansion Tank

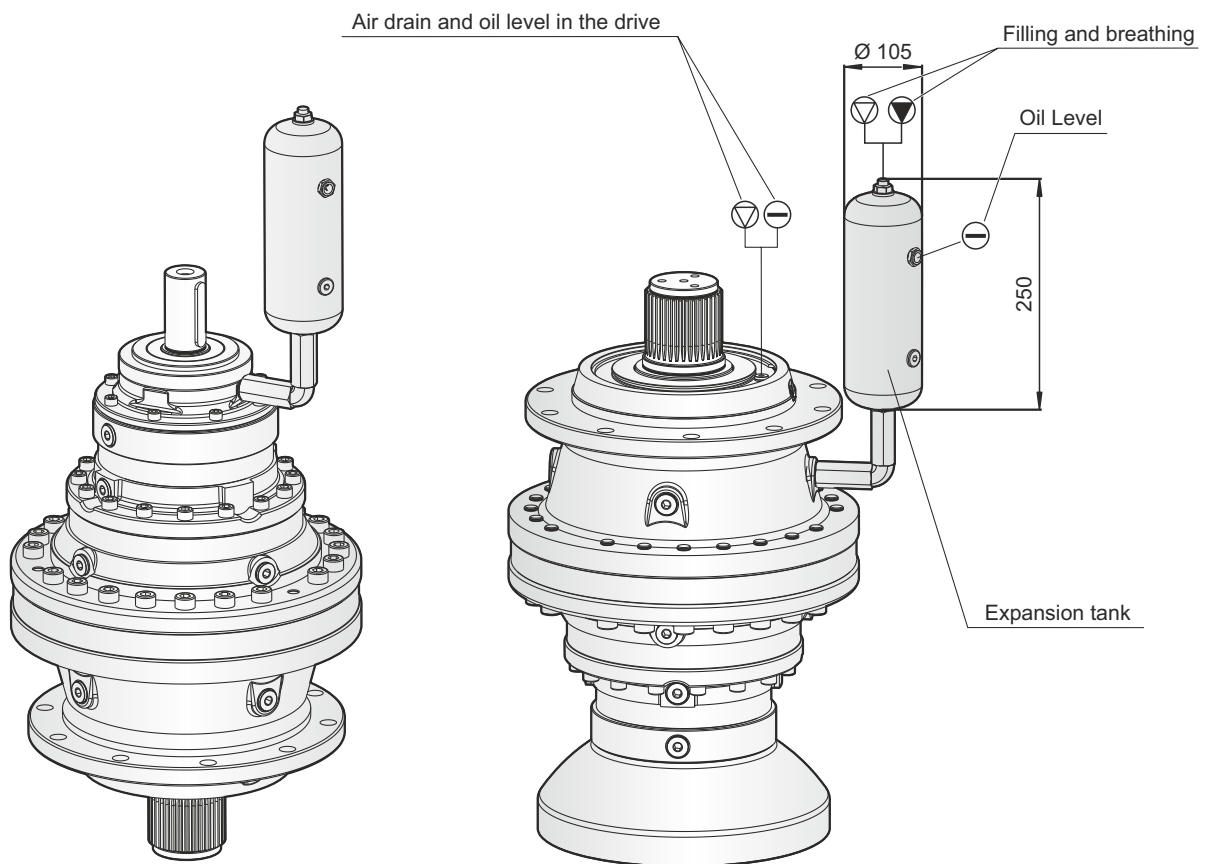

Filling Plug



Vent Plug



Oil Level Plug



7.2 Shrink Disc

Figure 9: Shrink Disc

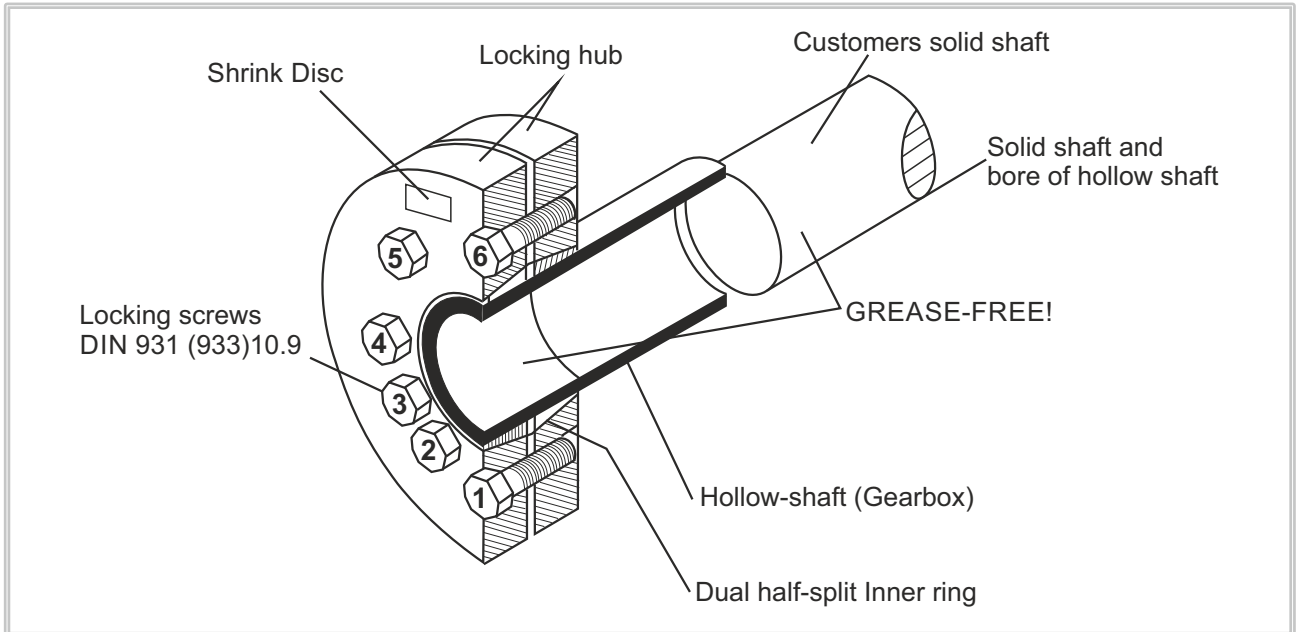

NOTE !

Shrink disc would be sent ready to assembly by manufacturer.
Please do not segment the shrink disc into pieces before assembly process.
There could be wounding risk during both assembly and disassembly.
Please obey instructions given below.



NOTE !

Do not tighten screws on the shrink disc without installing the shaft.
If it is tightened, hollow shaft could be damaged.

7.2.1 Mounting Position of the Shrink Disc;

- If there is, the shrink disc must be removed from the package.
- The clamping bolts are loosened but must not be removed. Must be squeezed with the help of hand until to get the space out of between the flanges and inner loop.
- The external clamping flange connected to the gear unit's shaft, shrink disc must be pushed on to the output shaft. Soft grease must applied to the hole at inner ring. (for easing the pushing process).
- The soft grease must be applied to the spacer side of customer applications solid shaft. The oil must not be touched the compressed side of the shrink disc. For not creating that kind of risk, the grease should not be applied directly on the spacer.
- The grease both on the gear unit's shaft and customer's application shaft must be fully cleaned and be ungreased.
- The Customer's applications solid shaft must be mounted completely to the hollow shaft to the shrink disc's shrinking area.
- To positioned the shrink disc, the clamping bolts must slightly tightened.
- The clamping bolts must be tightened at clockwise a few times respectively (approximately ¼ bolt tour per tour). Never be tightened diagonally.
- After tightened the clamping bolts, there should be an equal space between the clamping bolts. If this space is not ensured, the gear unit must be dismantled and the sensibility of the external tightened flange of the shrink disc must be controlled.



7.2.2 Demounting Position of the Shrink Disc;

- The clamping bolts must be loosened respectively a few times. (approximately ¼ bolt tour per tour) But clamping bolts must not be fully removed.
- The shrink disc should not be separated from the gear unit's shaft.
- The gear unit must be removed from customer's applications solid shaft.

	DANGER !
	If the shrink disc are mounted and dismantled incorrectly, the wounding danger could exist.

7.2.3 Cleaning of the Shrink Disc;

- Dismantled shrink disc before remounting, is not needed to subject the cracking process.
- Only the polluted surfaces of the shrink disc must be cleaned.
- The conical surfaces must be lubricated with one of the the solid material lubricants listed below.

Table 9: Lubrication Schedule While Cleaning of Shrink Disc

Lubricant (Mo S2)	Type
▶ Molykote 321 (Slippery lac)	▪ Spray
▶ Molykote Spray (Powder spray)	▪ Spray
▶ Molykote G Rapid	▪ Spray or paste
▶ Aemasol MO 19P	▪ Spray or paste
▶ Aemasol DIO-setral 57 N (Slippery lac)	▪ Spray

For the lubricating of clamping screws Molykote BR 2 or similar material must be used.

7.3 Torque Arm

Figure 10: Torque Arm

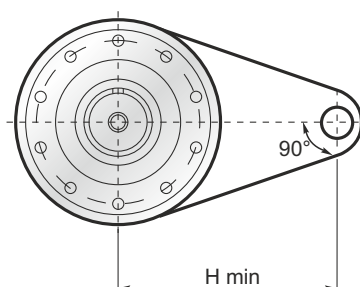

Catalog : PL/PLB

The torc arms in the FS type exits are the appurtenances used together with the shrink disc. If these torc arms are single supported, it is significant to take care of the Hmin value and 90 angle specified in the catalogue. Before to fasten the torc arm clean the mountage and hole faces and refine from the oil.



7.4 Backstop

Change of the lock and direction of the movement of machine incorrectly is prevented. In case of the use of lock, it is operated only the direction specified before.

	NOTE !
<p>The action of the motor in locking direction could cause fracturing of the lock.</p> <ul style="list-style-type: none"> - The motor absolutely must not rotated to the direction of locking. To provide specified direction of rotation, it must be careful that the motor is supplied by direct current. - For the purpose of controlling gear unit's output solid shaft/gear unit's output hollow shaft could be operated by half tour to the opposite direction of locking once. 	

The allowed direction of rotation is marked on the gear unit.

7.5 Input Accessories

PGR Industries reduction gears can be supplied with different input options.
By means of the input flanges with and without brake, the following accessories can be mounted:

Figure 11: Input Accessories

- Negative Modular Brakes

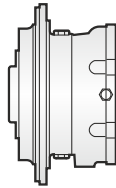

- Hydraulic Motors

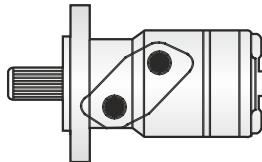

- Electric Motors

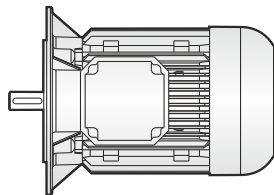

- Worm Gears

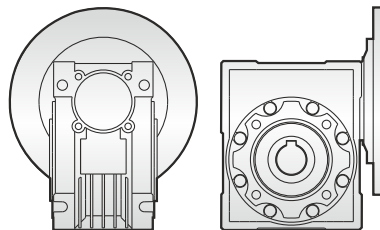

- Input Shafts

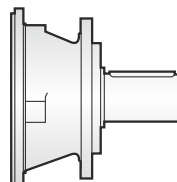



8.1 The Electrical Motor and Brake Connection

The connections must be made according to electric connection schema (If there is brake, it must be made according to brake connection schema).

- Must be sured that the supply voltage and frequency are the same as tag values.
- Both the protective tag values and connection must be controlled.
- If the motor is operated at the opposite direction, two stages must be changed.
- Unused cable entries should be closed.
- Not to have excessive load and stage failures, the protector must be used (stage protection or thermic etc.)
- The motor protection must be set to the nominal current.
- The gear unit and motor must be grounded against potential differences.
- The electrical motor and/or brake connections must be made by the experienced electric technicians.



DANGER !

Wrong voltage or connection would harm to electrical motor or environment.



8.2 The Electrical Motor Connection Schema

Three Phase Squirrel - Cage Motor

Figure 12: The Electrical Motor Connection Schema

- I. Terminal Box
- II. Circuit Breaker

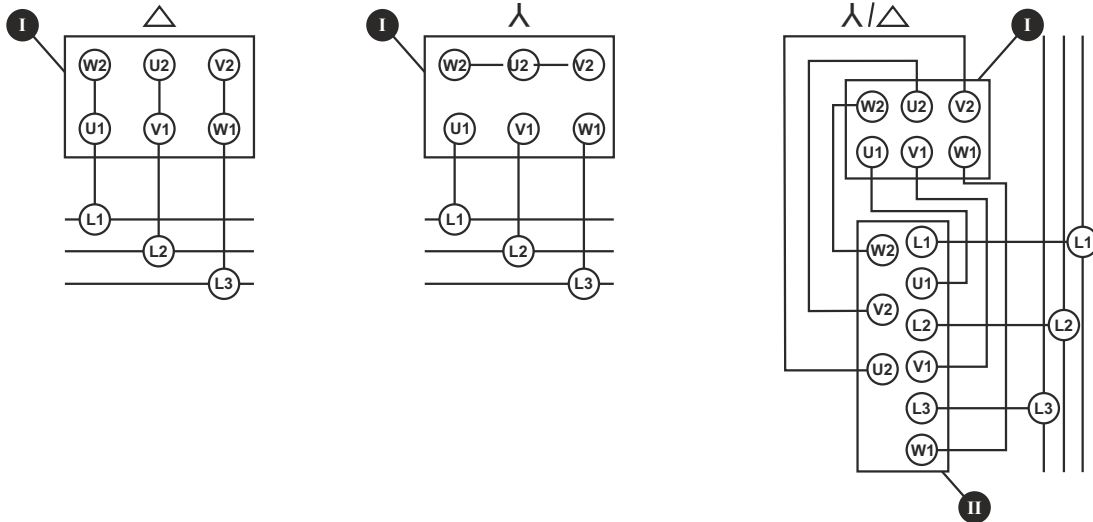

Wiring Diagram for Two - Separate - Winding Motor:

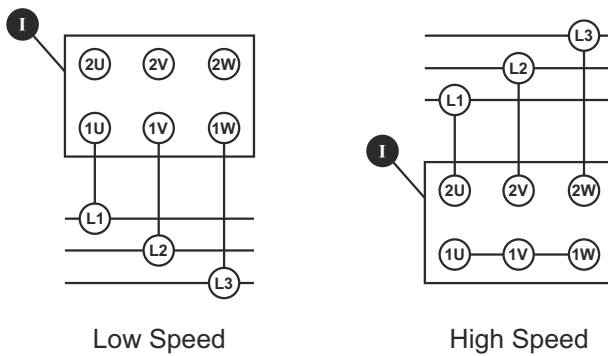

Dahlender Motor Connection Diagram:

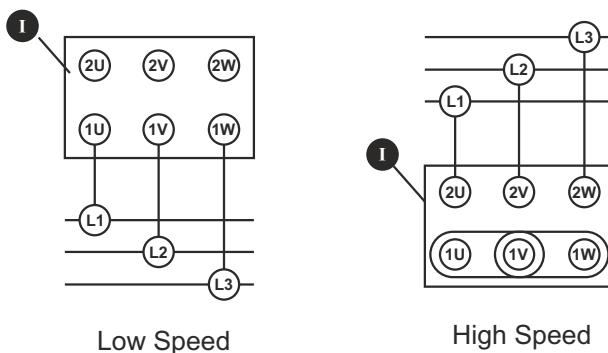



8.3 Standard Type Brake Anchorage Schema

Delayed Running Brake (400V)

Figure 13: Standard Type Brake Anchorage Schema

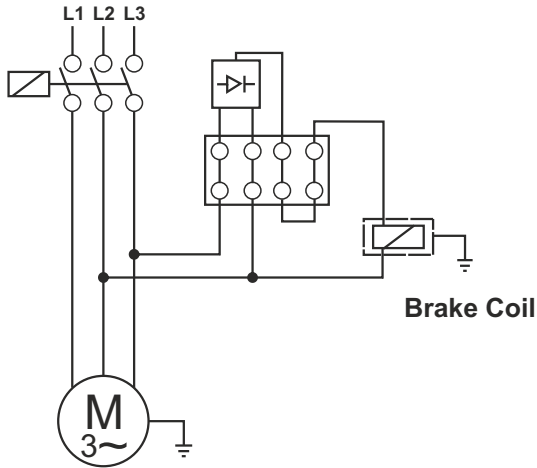

Sudden Brake (400V)

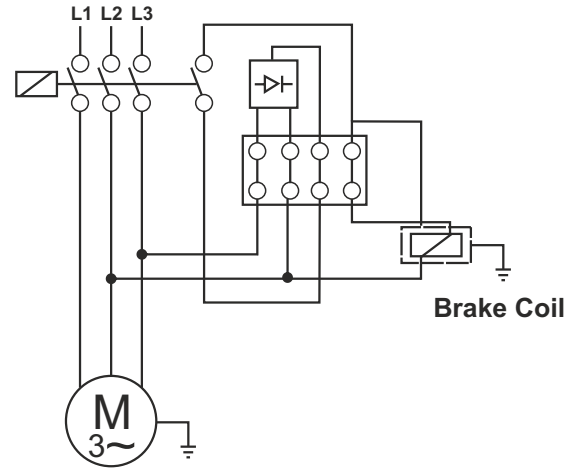

Delayed Running Brake (24V)

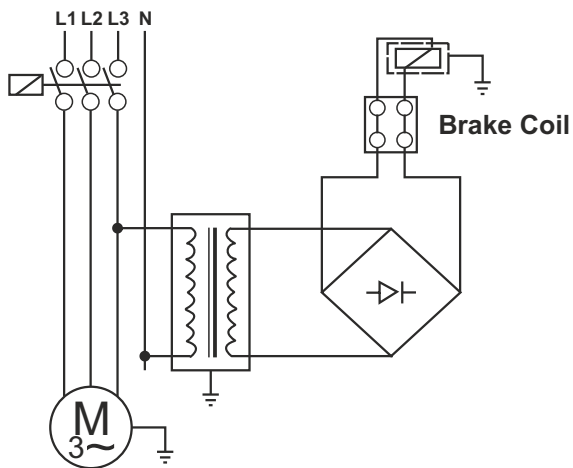

Sudden Brake (24V)

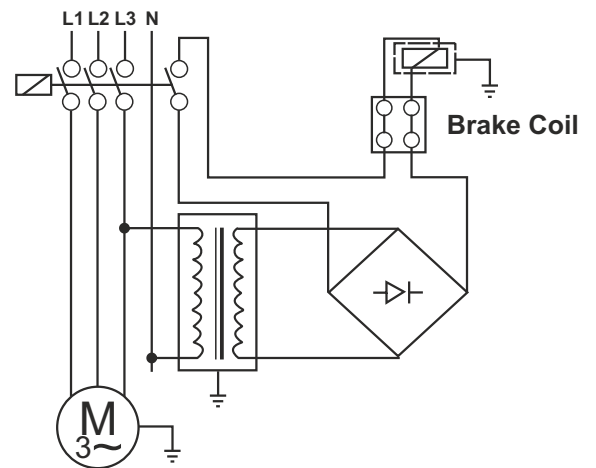

Please check brake coil by using a tester.

DELTA CONNECTION
Δ 230 V

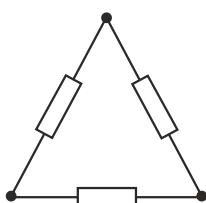

STAR CONNECTION
Λ 400 V

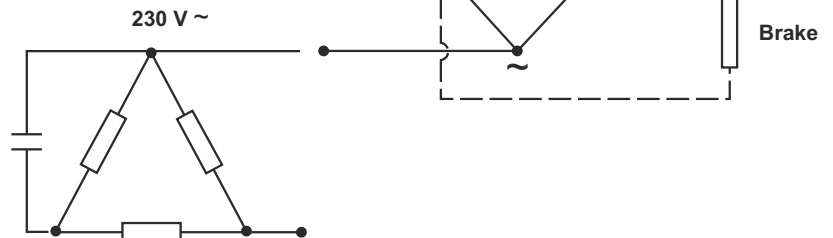
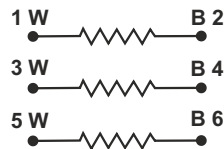
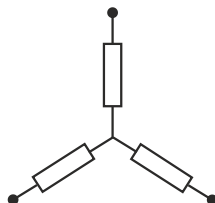



9.1 Product Disposal

Dismantle the machine, separating the parts following the instructions given in this manual. You must group the parts according to the materials they are made of: iron, aluminium, copper, plastic and rubber.

The parts must be disposed of by the relative centres in full compliance with the laws and force on the matter of dismantling and demolishing industrial waste.

Waste Oil: At the disposal of waste oil, please obey both to the environmental protection laws as well as rules and regulations those are in force into countries which the machine has been using of.

9.1.1 Disposal

The valid regulations must be taken into the consideration for the waste materials.

Table 10: Disposal Table

GEAR UNIT COMPONENTS	MATERIAL
Toothed wheels, shafts, rolling bearings, parallel keys, locking rings,...	Steel
Gear unit housing, housing components,...	Grey cast iron
Light alloy gear unit housing, light alloy gear unit housing components,...	Aluminium
Worm gears, bushes,...	Bronz
Radial seals, sealing caps, rubber components,...	Elastomers with steel
Coupling components	Plastic with steel
Flat seals	Asbestos - free sealing material
Gear oil	Additive mineral oil
Synthetic gear oil (rating plate code: CLP PG)	Polyglycol - based lubricants
Cooling spiral, embedding material of the cooling spiral, screw fittings	Copper, epoxy, yellow brass

	NOTE !
	Please do not diffuse any biologically indivisible materials, oil and noninclusive components (PVC,rubber,resins and etc.) to the environment.

	ATTENTION !
	Do not reuse damaged parts during inspection, only should be changed by expert personnels.



9.2 Troubleshooting

Table 11: Troubleshooting

NO	PROBLEM	OBSERVED	SOLUTION
1	Gearbox does not work.	The noise is not coming from gearbox. Output shaft of the gearbox is not rotating. Driver / frequency inverter is not be used.	Check the connection of electric motor, voltage and frequency. The values could be same with the values which are on the motor label. Look at to the motor usage guide. If the solution is not found look to the article 50.
2	Gearbox does not work.	The noise is not coming from gearbox. Output shaft of the gearbox is not rotating. Driver / frequency inverter is used.	Look to the guide of driver / frequency inverter or driver usage guide. Determine that error is not originated from driver / frequency inverter by seperating electric motor either from driver and frequency inverter and making direct connection to the motor.
3	Gearbox does not work.	A different noise is coming out of the gearbox. But gearbox and motor shaft are not rotating. Driver / frequency inverter or magnetic brake are not used.	The first thing that has to be made is to check whether motor connection, voltage and frequency are identical with motor label values. If there is not any problem, to pull out gearbox from the machine and try to operate in neutral. If gearbox works, the power of motor may not be enough to operate system. If the motor which connected to the gearbox is monophase, take off capacitors should be controlled. Even the motor does not work despite all tests and examinations, look at to the article 50.
4	Gearbox does not work.	A different noise is coming out of the gearbox. But gearbox and motor shaft are not rotating. Driver / frequency inverter or magnetic brake are used.	The frequency inverter or driver usage guide should be examined. Determine that error is originated whether from driver / frequency inverter by seperating electric motor either from driver and frequency inverter and making direct connection to the motor. If the gearbox does not work, look at to the article 50.
5	Gearbox does not work.	A different noise is coming out of the gearbox. But gearbox and motor shaft are not rotating. Magnetic brake is used.	It is necessary to check whether electric motor connection, voltage and frequency are identical with motor label values. Look at to the motor usage guide. Be sure that brake is working. If the brake is assembled by us to check whether it is made correctly according to the schema at the usage and maintenance instructions. If the error is not found to check whether the brake is operating by making direct connection to the brake appropriate to the brake voltage. When the electric is given, the noise of the opening of brake will come. If the brake is not working even by giving electric, the diode of brake could be in failure. To feed the motor directly according to the informations on the label when the brake is seperated from disc. If the problem is continuing, the power of the motor may not be enough. Look to the article 50.
6	Gearbox does not work at low speeds / frequencies.	Use driver / frequency inverter.	The motor feeding frequency is declining at low speeds. For the operating of motor at very low frequencies, it is essential to adjust motor parameters and frequency inverter parameters very well. Besides for the low speeds, there could be big changes even at the gearbox efficiency. To enlarge motor power and inverter or for to reach your requested cycle range, change the gearbox ratio.



NO	PROBLEM	OBSERVED	SOLUTION
7	Gearbox does not work after long awaitings or at mornings.	Environmental temperatures are dropping below -5°C.	The gearbox oil is not suitable to the environmental temperatures where it works. It is necessary to use low viscosity oils or to protect gearbox group from cold. To find proper oil look to usage guide or examine lubricating pages from the product catalogs. To work at higher environmental temperatures could be a solution. If the problem is continuing, the motor power should be increased.
8	Gearbox is very heating up.	You use worm screw type gearbox and environmental temperature is under +40°C.	When the gearbox is working under the full load, gauge gearbox surface temperature with heat meter. If it is under +90°C it is normal and no harm to gearbox. All worm screw and ATEX compatible helical gearboxes could be used up to the +120°C surface temperatures. If the temperature is above the +120°C and gearbox is ATEX compatible immediately stop gearbox and inform to PGR. Look to the article 50. If it is the product without ATEX, to check the oil amount according to the mountage position. Be sure that the mounting position written on the label and mounting position which gearbox is working should be identical. If not look to the article 50. To the gearboxes without worm screw types at heatings above +80°C, look to the articles 9 and 50.
9	Gearbox is very heating up.	You use helical gearboxes and environmental temperature is under +40°C.	When the gearbox is working under the full load, gauge gearbox surface temperature with heat meter. If it is under +90°C it is normal and no harm to the gearbox. All gearboxes with ATEX are designed to work at maximum +120°C. If the temperature is above +120°C and gearbox is ATEX compatible immediately stop gearbox and inform to PGR. The gearboxes without ATEX are designed to work at maximum +90°C temperature values. If the gearbox temperature is above the +90°C, control the oil amount according to mounting position. Be sure that the mounting position written on the label and mounting position which gearbox is working should be identical. If there is inconsistency look to the article 50.
10	Gearbox is very heating up.	Environmental temperature is above +40°C.	The standard gearboxes are designed to work at maximum +40°C. Temperatures above +40°C, special applications and additions should be done. In these situations please consult to PGR.
11	Gearbox is working noisy.	Noise is regular and perpetual.	Control the mobile machine elements. Operate gearbox without load by separating from the system. If you hear the same noise, bearings which belong to gearbox or motor could be in failure. Look to the article 50.
12	Gearbox is working noisy.	Noise is irregular.	Control the mobile machine elements. Operate gearbox without load by separating from the system. If the same noise is continuing, foreign objects could be in the oil. Change the oil and control the foreign objects in the oil. If the metal piece is found into the controlled oil, the gearbox could be damaged. Look to the article 50.



NO	PROBLEM	OBSERVED	SOLUTION
13	Gearbox is working noisy.	Noise is regular with clicking.	Control the mobile machine elements. Operate gearbox without load by seperating from the system. If the same noise is continuing, gearbox parts could be damaged. Look to the article 50.
14	Gearbox is working noisy.	Noise is regular and fluctuating.	Control the flexure of connection elements which connect to output shaft. Seperate element which is connected to output shaft and operate gearbox without load. If the same noise is continuing, look to the article 50.
15	Gearbox is working noisy.	Gearbox has motor with brake and noise is coming from the brake side.	The noises could be coming from the brake like in the shape of low level randomly tickings and it is normal. If the noise level is disturbing, brake could be damaged or there may be a problem at the gap adjustment between lining and disc. Look to the article 50.
16	Gearbox is working noisy.	You use frequency invertor and the noise is changing every time by the change of cycle.	Frequency invertor parameters may not be compatible with your used motor. Examine frequency invertor usage guide and if the same problem is continuing look to the article 50.
17	Oil leakage is existing.	Oil leakage from the seal.	If the environmental temperature is above +40°C and there is continious working over 16 hours, according to the mounting position pull out a plug which is on the top and use ventilation plug instead of it. If your situation is not suited to this, seal could be damaged. Look to the article 50.
18	Oil leakage is existing.	Oil is leaking from the plug.	If you use the ventilation plug, be sure that the plug is at the right position. According to the mounting position of the gearbox, plug which is on the top could be ventilation plug. The plug may loosened, clean the surface and plug itself and squeeze it again. If the same problem is continuing, look to the article 50.
19	Oil leakage is existing.	Oil is coming out of the the housing.	To observe where the oil is exactly coming from. It is leaking from the oil plug, oil cover or seal and could flow onto the housing. If the situation is like this, look to the article 18 and 19. If you sure that oil is coming out of the housing there could be cracks and fractures at the housing. Look to the article 50.
20	Oil leakage is existing.	Oil is coming out of the the cover.	A gasket that is used between cover and housing is not performing its leaktightness duty. Dismantle the cover clean the bottom side and assemble cover to its place by smearing liquid gasket. If the problem continues look to the article 50.
21	Gearbox is making regular vibrations when it is worked at the assemble point.	You use torc arm.	The reason of the vibration of gearbox is originated from the shaft flexure which gearbox is connected. When the torc arm is used, it has no harm to gearbox and it is usual situation.



NO	PROBLEM	OBSERVED	SOLUTION
22	Gearbox is making random vibrations when it is worked at the assemble point.	You use torc arm.	The reason of the vibration of gearbox is because of shaft flexure which the gearbox is connected and passing gap between shaft and bushing. Control your shaft hole passing tolerance. When the torc arm is used, it has no harm to gearbox and it is usual situation.
23	Motor is warming a lot.	Motor is working above its normal ampere. Environment is clear.	There could be overloading or motor power is insufficient. Motor could be in failure. Look to the article 50.
24	Motor is warming a lot.	Environment is dusty.	Be sure of whether motor fan bowl and motor cooler cores are clean for the air passing. If you use extra fan be sure that it is working. If there is invertor usage at the motor and works at low frequencies, the motor fan may not be sufficient. Use extra fan in these situations. If the problem continues look to the article 50.
25	Motor shaft is rotating but gearbox shaft is not.	Friction noise is coming from inside of gearbox or only there is motor noise.	There could be a damage at the gearbox parts. Look to the article 50.
26	Motor shaft is rotating but gearbox shaft is not.	You use chain geared or pinion geared at the output shaft of gearbox.	The damage could be originated of poligon impact formed by chain geared or from the radial load. Gearbox connection points may not be rigid enough. Be sure that you are able to use proper chain geared and pinion geared for used gearbox. Recalculate maximum allowable radial load according to this position. Look to the article 50.
27	Output shaft is cut.	You use either chain geared or pinion geared.	The damage could be originated of poligon impact formed by chain geared or from the radial load. Gearbox connection points may not be rigid enough. Be sure that you are able to use proper chain geared and pinion geared for used gearbox. Recalculate maximum allowable radial load according to this position. Look to the article 50.
28	Gearbox is stopping too late.	You use motor with brake	Control the electric connection schema of brake. Be sure that there is not assembled delayed diode onto the brake. If there is delayed diode, it could be changed. (Hoisting gearboxes are excluded PCS)
50	Service is required.	Informing of PGR Company.	Please contact with PGR company. Communication informations are given at the usage guides,catalogs. Mechanical parts can only be changed either by PGR or within the knowledge. Any change that is to be made without the knowledge of PGR would cancel both guarantee of product and all certificate declerations and remove the responsibilities of PGR over the product.

If there are problems or malfunctions different to the onesdescribed here contact a PGR Industries Assistance Centre.



10.1 Authorized Service

They are skill and qualified people, which are determined by company. They have education about electrical and mechanical subject.

	<p>NOTE !</p> <p>At below; the list took in place decided by our firm, authorized service and customer (user) which is about control and maintenance criterias/applications. Must be obliged to the informations which were given in the list. To the contrary that Usage and Maintenance directions become invalid.</p>
--	---

Table 12: Authorized Service

No	CRITERIA	MANUFACTURER (PGR)	AUTHORIZED SERVICE	CUSTOMER (USER)
1	Disassembly of geared unit	✓	✓	X
1.1	Case changing	✓	✓	X
1.2	Gear changing	✓	✓	X
1.3	Solid / shaft changing	✓	✓	X
1.4	Changing of all consumable material except sealing materials	✓	✓	X
2	Oil cup changing	✓	✓	✓
3	Seal changing	✓	✓	✓
4	Oil changing	✓	✓	✓
5	Motor montage to IEC adapter type	✓	✓	✓
6	Motor montage to PAM type	✓	✓	✓
7	Assembly of geared unit with W cylinder type	✓	✓	✓
8	Disassembly of motor from IEC / PAM type	✓	✓	✓

✓ : SUITABLE

X : NOT SUITABLE

2-3 : Send to the contaminated waste disposal (licensed firm).

4 : Send to the licensed firm for the purpose of disposal.

**11.1 Contact Information****FACTORY**

ATA OSB MAH. ASTİM 1. CAD. NO: 4, PK 105 Efeler / Aydın / TURKEY

Tel : +90 256 231 19 12 - 16 (pbx)
Fax : +90 256 231 19 17
Web : www.pgr.com.tr
e-mail : info@pgr.com.tr - satissonrasi@pgr.com.tr

ASSEMBLY FACTORY AND LOGISTICS CENTER

AYDIN ORGANİZE SANAYİ BÖLGESİ UMURLU MAH. NO:66 Efeler / Aydın / TURKEY

Tel : +90 256 231 19 12 - 16 (pbx)
Fax : +90 256 231 19 17
Web : www.pgr.com.tr
e-mail : info@pgr.com.tr - satissonrasi@pgr.com.tr

AREAS**ANKARA AREA**

AHI EVRAN CAD. 1203.SK NO:18 D:58-60 İSGEM Ostim / Ankara / TURKEY

Tel : +90 312 354 44 08
+90 312 385 86 68
Fax : +90 312 385 79 27
Web : www.pgr.com.tr
e-mail : ankara@pgr.com.tr

ISTANBUL AREA

ŞERİFALİ MAH. ALPTEKİN CAD. SÖYLEŞİ SOK. NO:31 Ümraniye / İstanbul / TURKEY

Web : www.pgr.com.tr
e-mail : istanbul@pgr.com.tr

GERMANY AREA

IN DER SCHLINGE 6, D-59227 Ahlen / GERMANY

Tel : +49 (0) 238 2855 7010
: +49 (0) 238 2855 7011
: +49 (0) 238 2855 7012
: +49 (0) 238 2855 7016
Web : www.pgr.com.tr
e-mail : info@pgrgermany.de

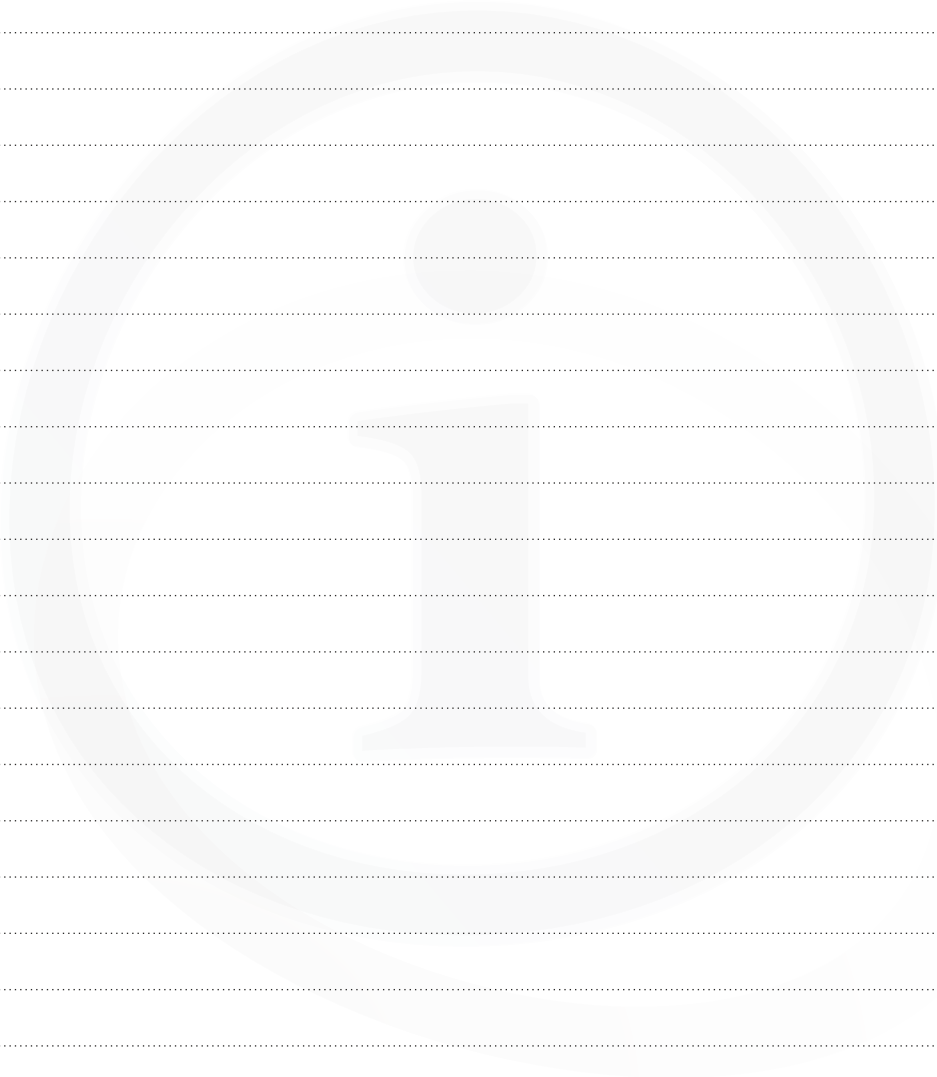

PGR[®] | **EN**
DRIVE TECHNOLOGIES



- Ata OSB Mah. Astim 1. Cad. No: 4, Pk 105 Efeler / Aydın / TÜRKİY
- T: +90 256 231 19 12 - 16 (pbx)
- F: +90 256 231 19 17
- info@pgr.com.tr - satissonrasi@pgr.com.tr
- www.pgr.com.tr