



PGR[®]
DRIVE TECHNOLOGIES

Transforming your energy into motion...
Verwandeln Sie Ihre Energie in Bewegung...



NEW PRODUCTS / NEUE PRODUKTE



PCD Series

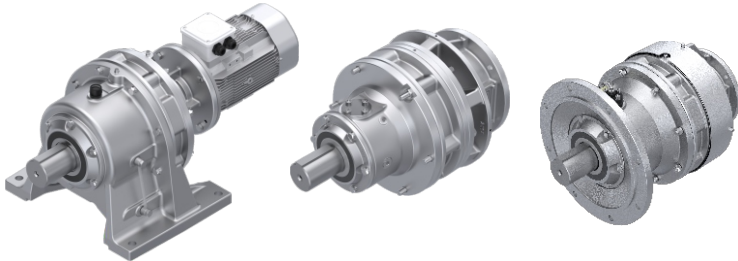

Cycloid Series Gear Units / Zykloidgetriebe

Power / Leistung	0.12 ... 95 kW
Torque / Moment	3 ... 74490 Nm
Ratio / Übersetzungsverhältnis	6 ... 7569

PEX Series



Extruder Gearboxes / Extrudergetriebe

Power / Leistung	7.5 ... 300 kW
Torque / Moment	1100 ... 160800 Nm
Ratio / Übersetzungsverhältnis	8 ... 50

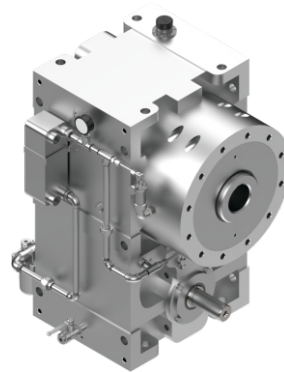

PZ Series

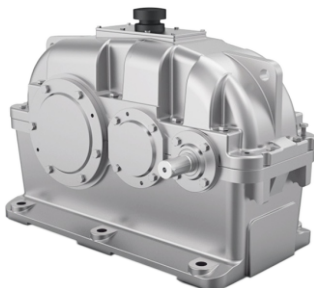

Cylindrical Gear Units / Zylindrische Getriebe

Power / Leistung	4 ... 6666 kW
Torque / Moment	7.5 ... 1200 Nm
Ratio / Übersetzungsverhältnis	1.25 ... 100

PH Series



Industrial Type Gear Units / Industriegetriebe

Power / Leistung	3.5 ... 4650 kW
Torque / Moment	2400 ... 480000 Nm
Ratio / Übersetzungsverhältnis	1.25 ... 450

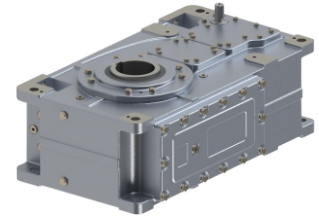
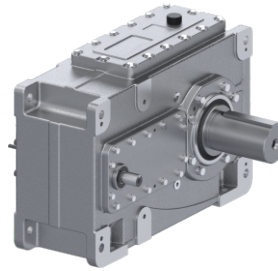

PB Series



Industrial Type Gear Units / Industriegetriebe

Power / Leistung	3.5 ... 4650 kW
Torque / Moment	2400 ... 480000 Nm
Ratio / Übersetzungsverhältnis	1.25 ... 450

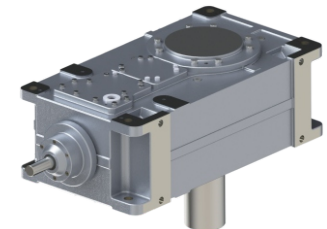
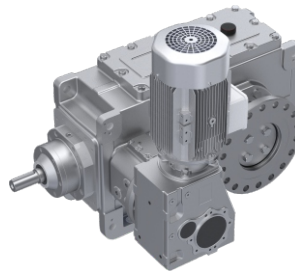

PL Series

Planet Gear Units / Planetengetriebe



Power / Leistung	0.12 ... 275 kW
Torque / Moment	86 ... 620000 Nm
Output Speed / Ausgangsgeschwindigkeit	0.4 ... 400 rpm
Ratio / Übersetzungsverhältnis	3.56 ... 2968.9



PLB Series

Planet Gear Units / Planetengetriebe

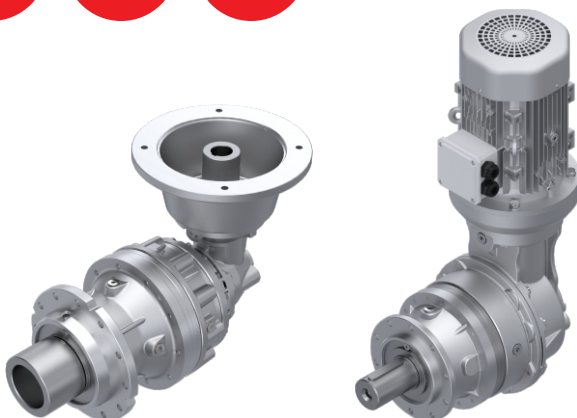

Power / Leistung	0.12 ... 275 kW
Torque / Moment	86 ... 620000 Nm
Output Speed / Ausgangsgeschwindigkeit	0.4 ... 400 rpm
Ratio / Übersetzungsverhältnis	3.56 ... 2968.9



PA Series

Helical Gear Units / Stirnradgetriebe

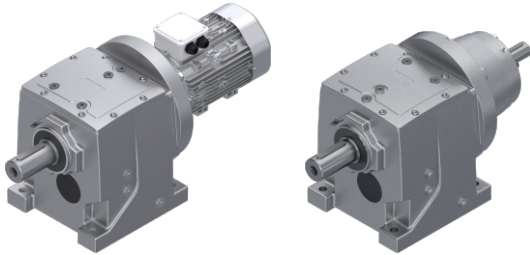

Power / Leistung	0.12 ... 240 kW
Torque / Moment	1 ... 23160 Nm
Output Speed / Ausgangsgeschwindigkeit	0.13 ... 1129 rpm
Ratio / Übersetzungsverhältnis	1.24 ... 11293.72



PF Series

Helical Gear Units / Stirnradgetriebe

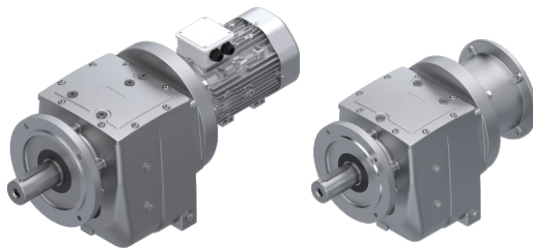

Power / Leistung	0.12 ... 240 kW
Torque / Moment	1 ... 23160 Nm
Output Speed / Ausgangsgeschwindigkeit	0.13 ... 1129 rpm
Ratio / Übersetzungsverhältnis	1.24 ... 11293.72

PD Series



Parallel Shaft Mounted Gear Units / Flachgetriebe

Power / Leistung	0.12 ... 245 kW
Torque / Moment	3 ... 36928 Nm
Output Speed / Ausgangsgeschwindigkeit	0.3 ... 348 rpm
Ratio / Übersetzungsverhältnis	4.02 ... 6601.35

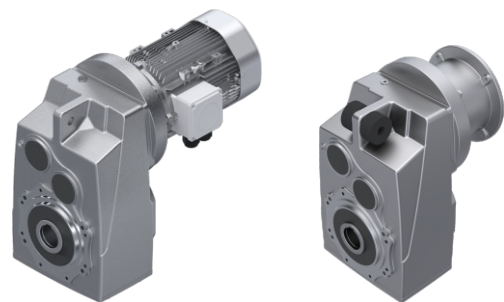

PM Series



Parallel Shaft Mounted Gear Units / Flachgetriebe

Power / Leistung	0.12 ... 245 kW
Torque / Moment	3 ... 36928 Nm
Output Speed / Ausgangsgeschwindigkeit	0.3 ... 348 rpm
Ratio / Übersetzungsverhältnis	4.02 ... 6601.35

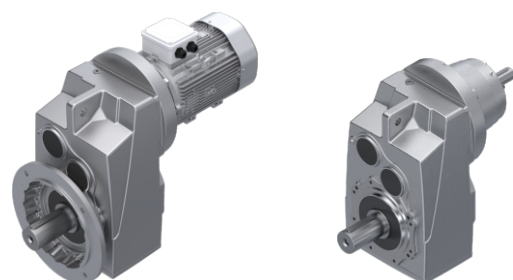

PKD Series

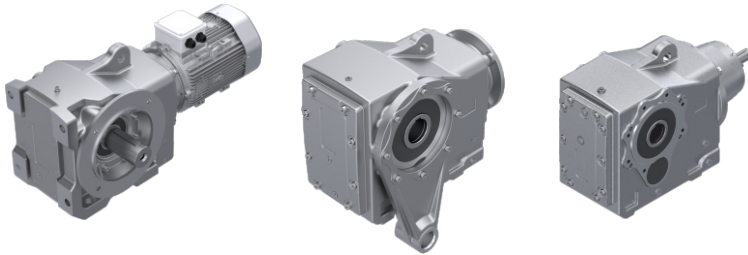

Helical Bevel Gear Units / Kegelradgetriebe

Power / Leistung	0.12 ... 465 kW
Torque / Moment	3 ... 51784 Nm
Output Speed / Ausgangsgeschwindigkeit	0.2 ... 363.5 rpm
Ratio / Übersetzungsverhältnis	3.85 ... 7842.34

PSH Series

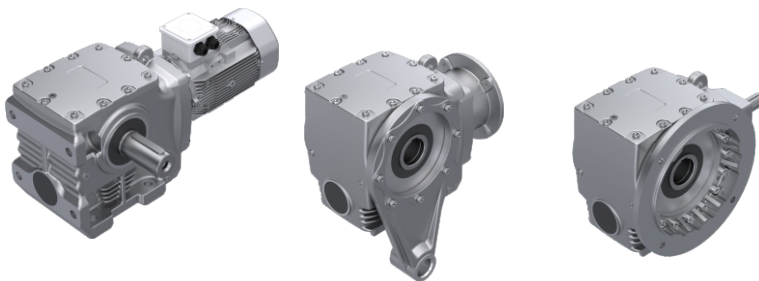

Helical Worm Gear Units / Stirnrad-Schneckengetriebe

Power / Leistung	0.12 ... 21.5 kW
Torque / Moment	3 ... 3157 Nm
Output Speed / Ausgangsgeschwindigkeit	0.4 ... 318 rpm
Ratio / Übersetzungsverhältnis	4.4 ... 3735.56

A Series



Helical Gear Units / Stirnradgetriebe

Power / Leistung	0.09 ... 136 kW
Torque / Moment	1.25 ... 8000 Nm
Output Speed / Ausgangsgeschwindigkeit	5 ... 1111 rpm
Ratio / Übersetzungsverhältnis	1.26 ... 282.17

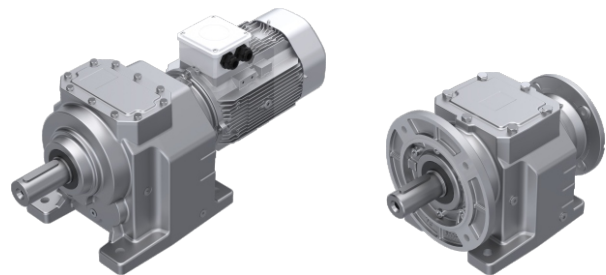

F Series



Helical Gear Units / Stirnradgetriebe

Power / Leistung	0.09 ... 136 kW
Torque / Moment	1.25 ... 8000 Nm
Output Speed / Ausgangsgeschwindigkeit	5 ... 1111 rpm
Ratio / Übersetzungsverhältnis	1.26 ... 282.17

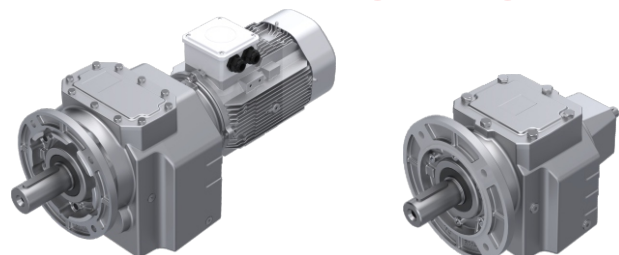

PMRVPLUS / PRVPLUS Series



Worm Gear Units / Schneckengetriebe

Power / Leistung	0.06 ... 27 kW
Torque / Moment	2 ... 6060 Nm
Output Speed / Ausgangsgeschwindigkeit	0.35 ... 280 rpm
Ratio / Übersetzungsverhältnis	5 ... 4000

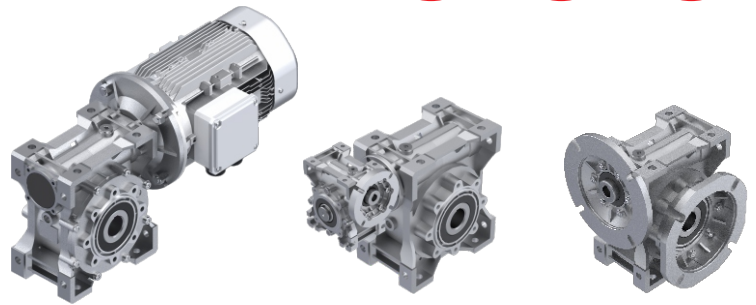

PCS Series



Crane Gear Units / Krangetriebe

Lifting Speed / Geschwindigkeit	0.5 ... 32 rpm
Power / Leistung	0.37 ... 55 kW
Load Capacity / Ladekapazität	1 ... 60 ton
Ratio / Übersetzungsverhältnis	37.54 ... 231.9

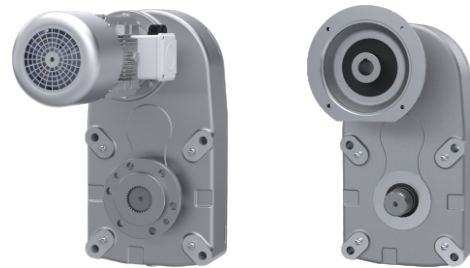

P Series

Shaft Mounted Helical Gear Units / Wellenmontierte Stirnradgetriebe

Power / Leistung	0.5 ... 270 kW
Torque / Moment	260 ... 42700 Nm
Ratio / Übersetzungsverhältnis	5 ... 20

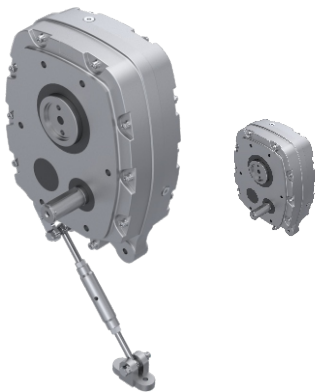

Pt/A Series

Shaft Mounted Helical Gear Units / Wellenmontierte Stirnradgetriebe

Power / Leistung	0.5 ... 240 kW
Torque / Moment	145 ... 17830 Nm
Ratio / Übersetzungsverhältnis	5 ... 35



PYK Series



Feeder Mixer Drives / Getriebe für Futtermischer

Capacity / Kapazität	0.5 ... 20 m ³
Torque / Moment	1000 ... 38250 Nm
Ratio / Übersetzungsverhältnis	8.72 ... 54.2

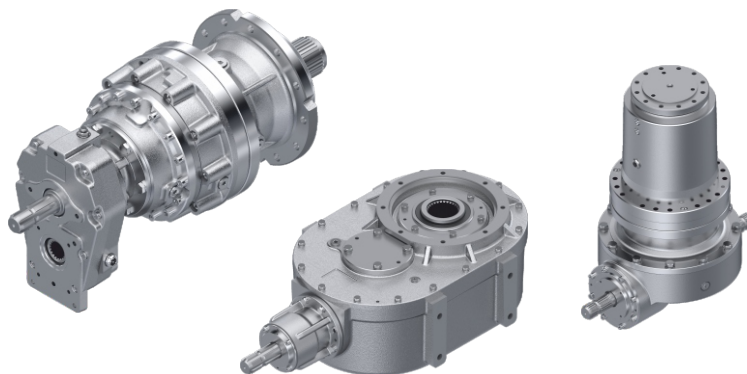

PX Series

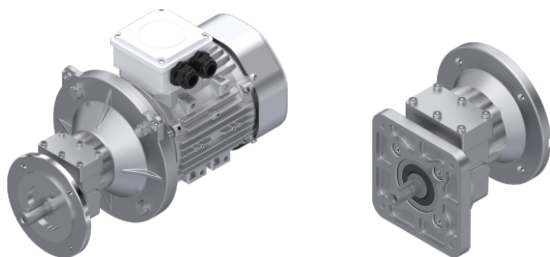

Gearmotors for Poultry Farms / Getriebe für die Geflügelfütterung

Power / Leistung	0.45 ... 1.10 kW
Torque / Moment	19 ... 24 Nm
Ratio / Übersetzungsverhältnis	2.5 ... 7.87



PPC Series

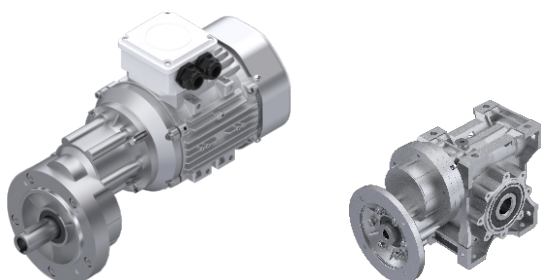

Gearmotors for Poultry Farms / Getriebe für die Geflügelfütterung

Power / Leistung	0.55 ... 1.10 kW
Torque / Moment	12 ... 22 Nm
Ratio / Übersetzungsverhältnis	3.0



PGR[®]
DRIVE TECHNOLOGIES



www.pgr.com.tr



info@pgr.com.tr



ATA OSB Mah. Astim 1.Cad. No: 4 Efeler - Aydın / TÜRKİYE



+90 256 231 19 12



/company/polat-group-reduktor



/polatgroupreduktor



/PolatGroupReduktor